

ELECTRICAL CIRCULAR DUCT HEATERS

EKA



Technical data
Mounng
Maintenance



Thank you for your purchase of this product. This manual describes how to use and install the supplied product. Be sure that you have read and understood its contents before using the heater.



The electrical heater's model and serial number are located on the label of the product.

WARNING! SAFETY REQUIREMENTS



Improper use of this heater can result in serious bodily injury due to hazards of fire and explosion, burn and electrical shock.



Use only with **electrical voltage** and **frequency** specified **on model label**. Do not perform any service with heater plugged in. Serious injury or death may occur if personnel come in contact with high voltage lead.



Parts of the heater become very hot when operating and immediately after operating. Severe burns may occur if the heater is not allowed to cool down properly before servicing.

TRANSPORTING AND STORING



All products are packed by producer for normal transporting conditions. For unloading and storing use proper lifter to prevent product damage and employees injuries. Do not lift product by power supply cable, connection box. Avoid impacts and impact loads.

Until final installation store products in dry place with humidity not more 70% (20°C), average ambient temperature must be 5-40°C. Storing place must be covered from water and dirt. Avoid long term storing. It is not recommended to store products more than 1 (one) year.

RECEIVING AND HANDLING



Inspect heater for any possible shipping damage. Inspect heater element wire for any deformation that could cause a short circuit or ground. Make sure that casing of the heater is not damaged.

SERVICE



No special service is required for electrical heaters, only to check electrical connection not less than 1 time per year.

QUALITY



We care about quality. 100% of heaters are tested before shipment.

DISPOSAL



Important environmental information about this product.

This symbol on the device or the package indicates that disposal of the device after its lifecycle could harm the environment. Do not dispose of the unit as unsorted municipal waste; it should be taken to a specialized company for recycling. Respect the local environmental rules.

If in doubt, contact your local waste disposal authorities.

WEEE

Table of contents

Descripon	4
Installaon and electric al connecon	5
Dimensions	7
Technical data	8
Model marking	10
Overheang pr otecon	11
Heaters EKA with integrated controller	11
Descripon of oper ang EKA NV ...	11
Descripon of oper ang EKA NI ...	11
Descripon of oper ang EKA NIS ...	12
Descripon of oper ang EKA NV ... (PT C...PS)	12
Descripon of oper ang EKA NI ... (PT C...PS)*	12
Descripon of oper ang EKA NIS ... (PT C...PS)*	13
Descripon of oper ang EKA NV ... 2NT C*	13
Descripon of oper ang EKA NI ... 2NT C*	13
Descripon of oper ang EKA NV ... PT C/2NTC*	14
Descripon of oper ang EKA NI ... PT C/2NTC*	14
Service	15
Troubleshooing	15
Warranty	15

Installation and electrical connection

Electrical duct heaters EKA can be installed horizontally in any position except electrical connection box downward and vertically (only if the air flow direction is upwards) (see Fig. 2).

Fig. 2

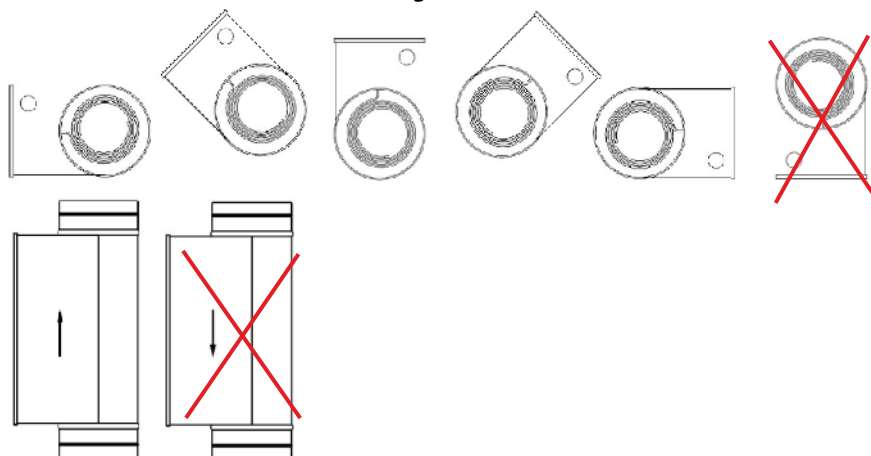

IMPORTANT:

The installation to the mains power supply may only be wired by a competent electrician. The power supply cable must be selected in accordance with the power of the heater. When installing these heaters, the standards and regulations in force in your country must be followed strictly. Within the installation, an electrical isolation automatic circuit breaker (not included) must be present, to enable the installer to cut all power supply lines. Automatic circuit breaker must be selected regarding power and nominal current (see the electrical rating plate on the lid of heater) of the heater and should have characteristic B. Connect the heater to the mains power supply, check that the voltage, frequency, power and current are the same as those indicated on the electrical rating plate. The heater must be earthed.

We recommend installing supply air temperature sensor in distance multiplied by the heater's diameter ($3 \times D$). For example: heater EKA diameter 200 mm, sensor's installation distance will be: $3 \times 200 = 600$ mm.

Fig. 3. Mounting example EKA NV/NI...

*- TR5K is used in EKA NI heater version.

** - Temperature set point knob is used in EKA NV heater version.

Fig. 3

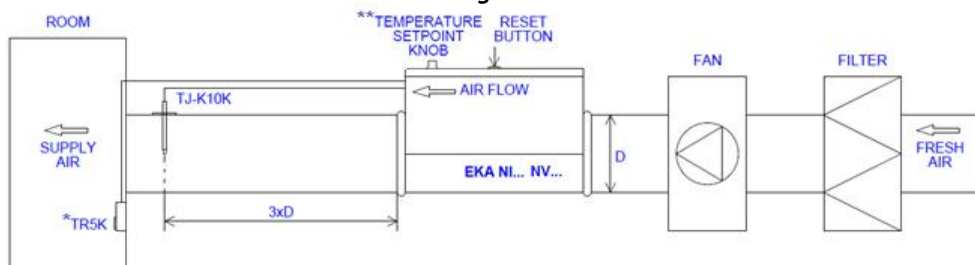

Guidelines for electric heater installation

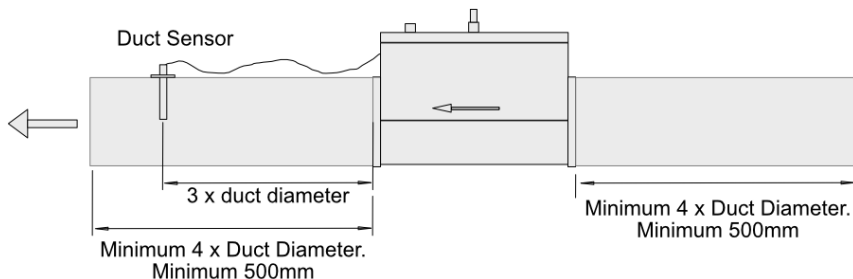

The heater installation is required to be within a straight section of metal duct.

There is a minimum length requirement of 4 x duct diameter (absolute min length of 500mm) to be installed on each side of the heater.

No bends or other angled fittings can be added within the minimum straight length of duct from the heater.

No bends or other angled fittings can be added within the minimum straight length of duct preceding the heater.

Duct Sensor Probe

The duct sensor is required to be fitted in the straight duct at a distance of 3 x duct diameter.

e.g. for 125mm duct, probe distance = 375mm.

for 150mm duct, probe distance = 450mm.

for 250mm duct, probe distance = 750mm.

The duct sensor probe should be installed at a depth of 1/2 the duct diameter.

e.g. for 125mm duct, probe depth = 62mm (approx).

for 150mm duct, probe depth = 75mm.

for 250mm duct, probe depth = 125mm.

Remote Thermostat Controller

For models supplied with a remote thermostat controller, these need to be mounted in the property and not at the heater.

It is recommended that the remote thermostat controller is positioned in a centralised area of the domestic dwelling or in the main living area if preferred (same principle used as a central heating thermostat).

The same guideline on position within a room for a central heating thermostat should be followed.

Fig. 4. Mounting example EKA NIS/ESKM...

*- External control signal (0...10VDC) is used in EKA NIS type heater.

** - External PWM control signal ON/OFF: ON (6...24VDC) is used in EKA ESKM type heater.

Fig. 4

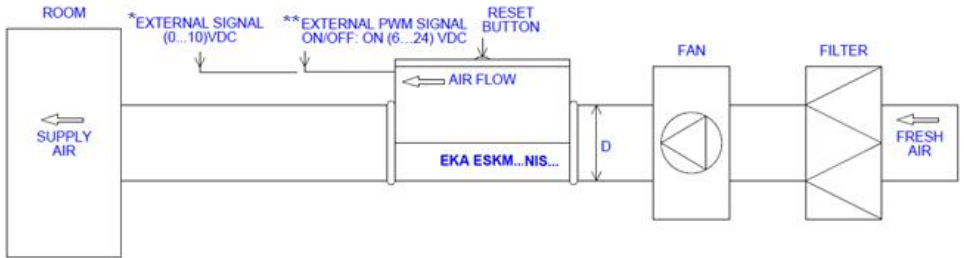

Fig. 5. Mounting example EKA NV/NI...2NTC...

*- Temperature set point knob and TR NTC10 are used in EKA NV 2NTC heater version.

** - TR5K NTC10 is used in EKA NI 2NTC heater version.

Fig. 5

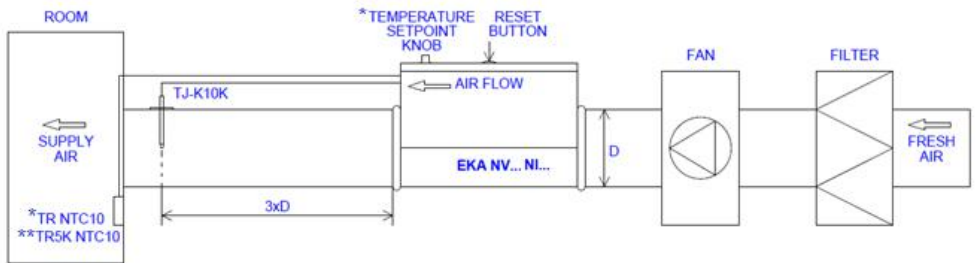

Fig. 6. Mounting example EKA NV/NI... (Preheater)

** - TR5K used only in EKA NI pre-heater version.

*- Temperature set point knob used only in EKA NV pre-heater version.

Fig. 6

AHU – Air handling unit

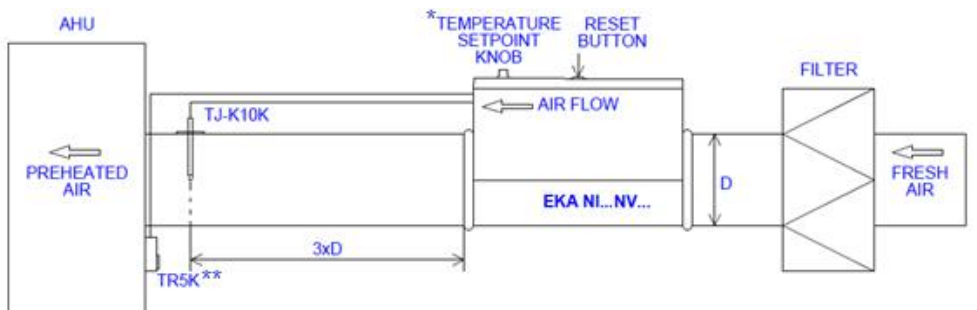
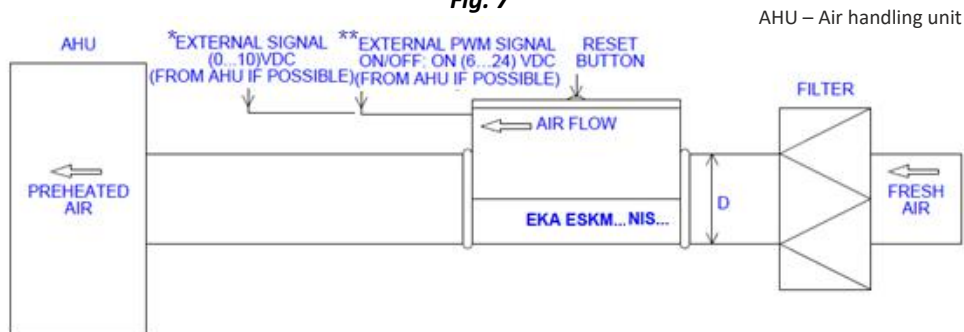

Fig. 7. Mounting example EKA NIS/ESKM... (Preheater)

*- External control signal 0...10VDC (from AHU if possible) is used in EKA NIS type pre-heater.

** - External PWM control signal ON/OFF: ON 6...24VDC (from AHU if possible) is used in EKA ESKM type pre-heater.

Fig. 7



AHU – Air handling unit

Dimensions

Fig. 8

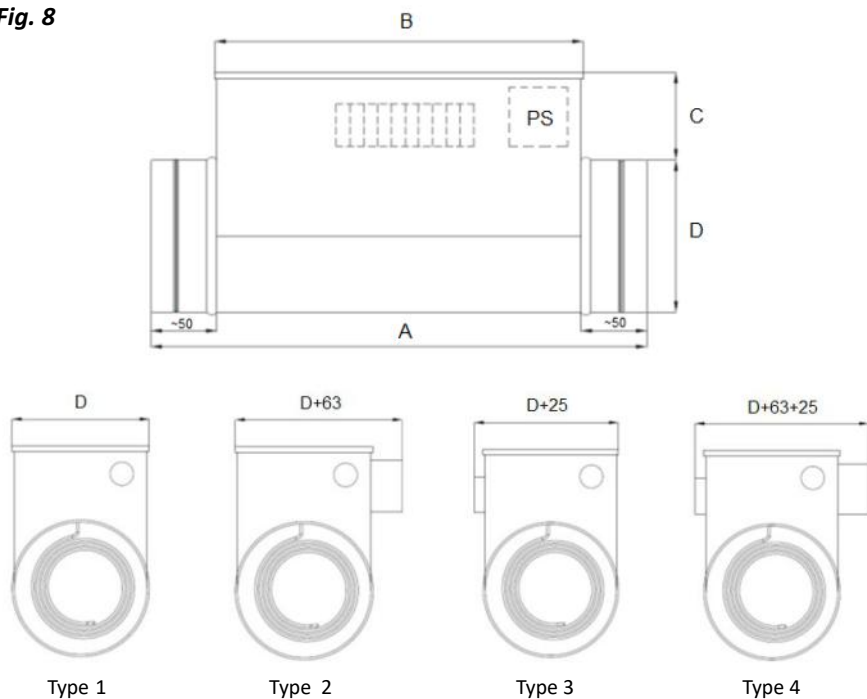

Type 1 – Standard EKA heater dimensions;

Type 2 – EKA heater with external pressure relay dimensions;

Type 3 – EKA heater with external cooling radiator dimensions;

Type 4 – EKA heater with external cooling radiator and pressure relay dimensions.

<i>Heater type</i>	<i>A(mm)</i>	<i>B(mm)</i>	<i>C(mm)</i>	<i>D(mm)</i>
EKA 100	370	276	71	100
EKA 125	370	276	71	125
EKA 150	370	276	71	150
EKA 160	370	276	71	160
EKA 200	370	276	71	200
EKA 250	370	276	71	250
EKA 250-12kW	500	402	71	250
EKA 250-15kW	630	532	71	250
EKA 315	373	276	71	315
EKA 315-12kW	500	402	71	315
EKA 315-15kW	630	532	71	315
EKA 315-18kW	630	532	71	315
EKA 355	373	276	71	355
EKA 355-12kW	500	402	71	355
EKA 355-15kW	630	532	71	355
EKA 355-18kW	630	532	71	355
EKA 400	373	276	81	400
EKA 400-12kW	500	402	81	400
EKA 400-15kW	630	532	81	400
EKA 400-18kW	630	532	81	400
EKA 400-21kW	770	672	81	400
EKA 400-24kW	880	782	81	400
EKA 450	373	276	81	450
EKA 500	373	276	81	500
EKA 500-12kW	500	402	81	500
EKA 500-15kW	630	532	81	500
EKA 500-18kW	630	532	81	500
EKA 500-21kW	770	672	81	500
EKA 500-24kW	880	782	81	500

Technical data

<i>EKA</i>	<i>ø(mm)</i>	<i>Min. airflow (m³/h)</i>	<i>Power supply (VAC/50Hz)</i>	<i>Power (kW)</i>	<i>Available heating elements (kW)</i>
EKA 100	100	45	1~230	0,3...1,8	0,3
EKA 125	125	70	1~230	0,3...3,6	0,3/0,6
EKA 150	150	100	1~230	1,2...3,0	0,6/1,0
EKA 160	160	110	1~230	0,3...7,2	0,3/0,6/1,0/1,2
			2~400	1,0...6,0	1,0
			3~400	3,0...6,0	1,0
EKA 200	200	170	1~230	0,3...7,2	0,3/0,6/1,0/1,2
			2~400	1,0...6,0	1,0
			3~400	3,0...9,0	1,0/1,5
EKA 250	250	265	1~230	0,3...7,2	0,3/0,6/1,0/1,2
			2~400	1,0...9,0	1,0/1,5
			3~400	3,0...9,0	1,0/1,5
EKA 250-12kW	250	265	3~400	12,0	1,0/1,5
EKA 250-15kW	250	265	3~400	15,0	1,0/1,5
EKA 315	315	425	1~230	0,6...9,0	0,6/1,0/1,2
			2~400	1,0...9,0	1,0/1,5
			3~400	3,0...9,0	1,0/1,5

EKA 315-12kW	315	425	2~400	12	1,0/1,5
			3~400	12	1,0/1,5
EKA 315-15kW	315	425	2~400	15	1,0/1,5
			3~400	15	1,0/1,5
EKA 315-18kW	315	425	2~400	18	1,0/1,5
			3~400	18	1,0/1,5
EKA 355	355	535	1~230	0,6...9,0	0,6/1,0/1,2
			2~400	1,0...9,0	1,0/1,5
			3~400	3,0...9,0	1,0/1,5
EKA 355-12kW	355	535	2~400	12	1,0/1,5
			3~400	12	1,0/1,5
EKA 355-15kW	355	535	2~400	15	1,0/1,5
			3~400	15	1,0/1,5
EKA 355-18kW	355	535	2~400	18	1,0/1,5
			3~400	18	1,0/1,5
EKA 400	400	680	1~230	0,6...9,0	0,6/1,0/1,2
			2~400	1,0...9,0	1,0/1,5
			3~400	3,0...9,0	1,0/1,5
EKA 400-12kW	400	680	1~230	9	1,0
			2~400	12	1,0/1,5
			3~400	12	1,0/1,5
EKA 400-15kW	400	680	1~230	12	1,0
			2~400	15	1,0/1,5
			3~400	15	1,0/1,5
EKA 400-18kW	400	680	2~400	18	1,0/1,5
			3~400	18	1,0/1,5
EKA 400-21kW	400	680	3~400	21	1,0/1,5
EKA 400-24kW	400	680	3~400	24	1,0/1,5
EKA 500	500	1060	1~230	0,6...9,0	0,6/1,0/1,2
			2~400	1,0...9,0	1,0/1,5
			3~400	3,0...9,0	1,0/1,5
EKA 500-12kW	500	1060	1~230	9	1,0
			2~400	12	1,0/1,5
			3~400	12	1,0/1,5
EKA 500-15kW	500	1060	1~230	12	1,0
			2~400	15	1,0/1,5
			3~400	15	1,0/1,5
EKA 500-18kW	500	1060	2~400	18	1,0/1,5
			3~400	18	1,0/1,5
EKA 500-21kW	500	1060	3~400	21	1,0/1,5
EKA 500-24kW	500	1060	3~400	24	1,0/1,5

This declaroon is in c onformity with the requirements of the standards:

LST EN 60335-2-30:2010+AC:2010+A11:2012+AC:2015 (EN60335-2-30:2009+ AC:2010+ A11:2012+ +AC:2014);
LST EN61000-4-2:2009 (EN61000-4-2:2009);
LST EN 61000-4-3:2006+A1:2008+A2:2010 (EN 61000-4-3:2006+A1:2008+A2:2010);
LST EN 61000-4-4:2013 (EN 61000-4-4:2012);
LST EN 61000-4-5:2014 (EN 61000-4-5:2014);
LST EN 61000-4-11:2004 (EN 61000-4-11:2004);
LST EN 61000-6-2:2005 (EN 61000-6-2:2005);
LST EN 61000-3-2:2014 (EN 61000-3-2:2014);
LST EN 61000-6-3:2007 + A1:2011 (EN 61000-6-3:2007 + A1:2011);
LST EN 61000-3-3:2014 (EN 61000-3-3:2013).

and therefore complies with the essential requirements and provisions of the (LVD) 2014/35/EC, (EMC) 2014/30 EC, (RoHS) 2011/65/EU and REACH.

The CE mark is affixed.

Model marking

EKA 100-0.3-1f without integrated control

1 2 3

1 – Duct diameter (mm)

100 – 100 mm

125 – 125 mm

150 – 150 mm

160 – 160 mm

200 – 200 mm

315 – 315 mm

355 – 355 mm

400 – 400 mm

450 – 450 mm

450 – 450 mm

500 – 500 mm

2 – Heating power (kW)

0.3 – 0,3 kW ... **24.0** – 24,0 kW

3 – Input voltage:

1f – Single phase 230V

2f – 2-phase 400V

3f – 3-phase 400V

3f – 3-phase 230V (*on request*)

EKA NV 100-0.3-1f PTC/2NTC with integrated controller

1A 1B 2 3 4

1A – Control type:

NV – Potentiometer for temperature control is on the lid of the heater

NI – External wired remote setpoint knob (*TR5K*) for temperature control

NIS – External wired remote (*0...10*) VDC signal for temperature control (*analog input*)

ESKM – External wired remote PWM (*ON/OFF: ON (6...24) VDC*) signal for temperature control

1B – Duct diameter (mm)

100 – 100 mm

125 – 125 mm

150 – 150 mm

160 – 160 mm

200 – 200 mm

315 – 315 mm

355 – 355 mm

400 – 400 mm

450 – 450 mm

450 – 450 mm

500 – 500 mm

2 – Heating power (kW)

0.3 – 0,3 kW ... **24.0** – 24,0 kW (*NV, NI, NIS*) >15 kW with mounted additional step

0.3 – 0,3 kW ... **15.0** – 15,0 kW (*ESKM*)

3 – Input voltage:

1f – Single phase 230V

2f – 2-phase 400V

3f – 3-phase 400V

3f – 3-phase 230V (*on request*)

4 – Additional accessories:

PS – Differential pressure switch for air flow detection

PTC – Sensor for minimum air velocity detection

PTC/PS – Sensor for minimum air velocity detection and diff. pressure switch for air flow detection

PTC/K – Sensor for minimum air velocity detection and contactor for overheat protection

2NTC – 2 sensors for the air temperature measuring

PTC/2NTC – Sensor for min. air velocity detection and 2 sensors for the air temperature measuring

Overheating protection

Two overheat protection thermostats are installed in the electrical circular heater EKA. The first one with automatic reset, turns off the heating when the temperature reaches 50 °C and turns on when the temperature drops below 50 °C. The second with manual reset, turns off the heating when the temperature reaches 100 °C. In this case need to figure the cause of the overheating of the heater. Eliminate overheating cause, press „RESET“ button on heaters cover.

Additional overheating thermostat (with automatic reset) is installed in the EKA heater with ESKM to protect the ESKM controller. This thermostat turns off the heating when the temperature reaches 70 °C and turns on when the temperature drops below 70 °C.

Heaters EKA with integrated controller

Table 1. Technical characteristics of controller EKR-K...

Power supply depending on model	single phase 230V / 2 - phase 400V / 3 - phase 400V
Power consumption in standby mode	0,1VA
Ambient temperature	0...50 °C
Relative humidity	Max. 90 % RH (<i>non-condensing</i>)

Description of operating EKA NV ...

Electrical duct heaters EKA NV ... are designed with integrated temperature control, one temperature sensor, setpoint potentiometer knob is integrated on the heater lid.

When the heater power supply is switched on, LED 6 on the controller (EKR-K...) PCB (*see Fig. 1 on page 4*) flashes once every 8 seconds if setpoint is 0 °C and every second if setpoint is higher than 0 °C. If controller turns on the heating depending on the demand, LED 5 lights (*see Fig. 1 on page 4*).

Heaters EKA NV ... operates by the supply (TJ-K10K) air temperature sensor. Setpoint temperature (0...30) °C. There can be set the different desired (setpoint) air temperature by potentiometer on the top of the heater casing.

IMPORTANT: If failure appears, power supply must be switched off and only then performed fault elimination works.

Description of operating EKA NI ...

Electrical duct heaters EKA NI ... are designed with integrated temperature control, one temperature sensor, wired remote control panel (TR5K) for temperature setpoint.

When the heater power supply is switched on, LED 6 on the controller (EKR-K...) PCB (*see Fig. 1 on page 4*) flashes once every 8 seconds if setpoint is 0 °C and every second if setpoint is higher than 0 °C. If controller turns on the heating depending on the demand, LED 5 lights (*see Fig. 1 on page 4*).

Heaters EKA NI ... operates by the supply (TJ-K10K) air temperature sensor. Setpoint temperature (0...30) °C.

There can be set the different desired (setpoint) air temperature by wired remote control panel.

If LED 6 lights continuously it means that there is a failure of: supply (TJ-K10K) air temperature sensor or wired remote control panel TR5K.

IMPORTANT: If failure appears, power supply must be switched off and only then performed fault elimination works.

Description of operating EKA NIS ...

Electrical duct heaters EKA NIS ... are designed for the heaters power (0...100) % control by analog signal input (0...10) VDC.

When the heater power supply is switched on, LED 6 on the controller (EKR-K...) PCB (*see Fig. 1 on page 4*) flashes every second. If controller turns on the heating depending on analog signal, LED 5 lights (*see Fig. 1 on page 4*).

Description of operating EKA NV ... (PTC...PS)

Electrical duct heaters EKA NV ... (PTC...PS) are designed with integrated temperature control, PTC (air velocity), PS (air pressure) and temperature sensors, setpoint potentiometer knob is integrated on the heater lid.

When the heater power supply is switched on, controller (EKR-K...) is in preparation mode for 30 seconds, LED 1 flashes once every 5 seconds. If air velocity is detected by PTC sensor (rapid LED 1 flashes when Min. 1,5 m/s is detected) and air pressure is greater than min 20kPa after preparation mode ends, LED 1 will start to flash once every second and controller will initiate the heating based on demand, LED 2 is indicated when heating is initiated. If there is no air velocity detected and or there is not enough pressure in the duct, controller will not initiate the heating until air velocity and or pressure is detected. Heaters EKA NV... (PTC...PS) operates by the supply (TJ-K10K) air temperature sensor.

EKA NV ... PTC ... setpoint temperature (0...30) °C

EKA NV ... PTC/PS setpoint temperature (-10...50) °C

There can be set the different desired (setpoint) air temperature by potentiometer on the top of the heater casing.

Pre-heater casing and air duct before pre-heater should be insulated with rock wool 10cm ($R \sim 2,4 \text{ m}^2 \text{ K/W}$).

Depending on the mounting position of the heater in the duct relative to the motor (pre- or post-motor), the pressure hose must be placed on the "-" or "+" pipe, respectively.

IMPORTANT: If failure appears, power supply must be switched off and only then performed fault elimination works.

Description of operating EKA NI ... (PTC...PS)*

Electrical duct heaters EKA NI ... (PTC...PS) are designed with integrated temperature control, PTC (air velocity) PS (air pressure) and temperature sensors, wired remote control panel (TR5K) for temperature setpoint.

When the heater power supply is switched on, controller (EKR-K...) is in preparation mode for 30 seconds, LED 1 flashes once every 5 seconds. If air velocity is detected by PTC sensor (rapid LED 1 flashes when Min. 1,5 m/s is detected) and air pressure is greater than min 20kPa after preparation mode ends, LED 1 will start to flash once every second and controller will initiate the heating based on demand, LED 2 is indicated when heating is initiated. If there is no air velocity detected and or there is not enough pressure in the duct, controller will not initiate the heating until air velocity and or pressure is detected.

Heaters EKA NI ... (PTC...PS) operates by the supply (TJ-K10K) air temperature sensor.

EKA NI ... PTC ... setpoint temperature (0...30) °C

EKA NI ... PTC/PS setpoint temperature (-10...50) °C

There can be set the different desired (setpoint) air temperature by wired remote control panel.

Pre-heater casing and air duct before pre-heater should be insulated with rock wool 10cm ($R \sim 2,4 \text{ m}^2 \text{ K/W}$).

Depending on the mounting position of the heater in the duct relative to the motor (pre- or post-motor), the pressure hose must be placed on the "-" or "+" pipe, respectively.

IMPORTANT: If failure appears, power supply must be switched off and only then performed fault elimination works.

* - non standard option. For more information please contact sales@ventmak.a.it

Description of operating EKA NIS ... (PTC...PS) *

Electrical duct heaters EKA NIS ... (PTC...PS) are designed for the heaters power (0...100) % control by analog signal input (0...10) VDC, with integrated PTC (air velocity) and PS (air pressure) sensors.

When the heater power supply is switched on, controller (EKR-K...) is in preparation mode for 30 seconds, LED 1 flashes once every 5 seconds. If air velocity is detected by PTC sensor (rapid LED 1 flashes when Min. 1,5 m/s is detected) and air pressure is greater than min 20kPa after preparation mode ends, LED 1 will start to flash once every second and controller will initiate the heating based on demand, LED 2 is indicated when heating is initiated. If there is no air velocity detected and/or there is not enough pressure in the duct, controller will not initiate the heating until air velocity and/or pressure is detected.

Pre-heater casing and air duct before pre-heater should be insulated with rock wool 10cm ($R \sim 2,4 \text{ m}^2 \text{ K/W}$).

Depending on the mounting position of the heater in the duct relative to the motor (pre- or post-motor), the pressure hose must be placed on the "-" or "+" pipe, respectively.

IMPORTANT: If failure appears, power supply must be switched off and only then performed fault elimination works.

* - non standard option. For more information please contact sales@ventmak.a.lt

Description of operating EKA NV ... 2NTC*

Electrical duct heaters EKA NV ... 2NTC are designed with integrated temperature control, two temperature sensors, potentiometer on the top of the heater casing for temperature setpoint.

When the heater power supply is switched on, LED 6 on the controller (EKR-K...) PCB (see Fig. 1 on page 4) flashes depending on the operating mode. If controller turns on the heating depending on the demand, LED 5 lights (see Fig. 1 on page 4).

Heaters EKA NV ... 2NTC can operate in two modes:

1. Control by the supply air temperature sensor (TJ-K10K), when the first (1) switch of JP1 -(R37) (see Fig. 1 on page 4) is in position ON. LED 6 flashes twice per second. Set point temperature (0...30) °C.

2. Control by the supply (TJ-K10K) and by the room (NTC10) air temperature sensor, when the first (1) switch of JP1 -(R37) (see Fig. 1 on page 4) is in position OFF. LED 6 flashes once per second. Setpoint temperature (15...30) °C. In this mode is preprogrammed the minimum (15°C) and the maximum (45°C) temperatures of supply air. The room air temperature sensor is mounted in the wired remote control panel TR5K NTC10.

Depending on the operating mode there can be set the different desired (setpoint) air temperature by wired remote control panel TR5K NTC10.

IMPORTANT: If failure appears, power supply must be switched off and only then performed fault elimination works.

* - non standard option. For more information please contact sales@ventmak.a.lt

Description of operating EKA NI ... 2NTC*

Electrical duct heaters EKA NI ... 2NTC are designed with integrated temperature control, two temperature sensors, wired remote control panel (TR5K NTC10) for temperature setpoint.

When the heater power supply is switched on, LED 6 on the controller (EKR-K...) PCB (see Fig. 1 on page 4) flashes depending on the operating mode. If controller turns on the heating depending on the demand, LED 5 lights (see Fig. 1 on page 4).

Heaters EKA NI ... 2NTC can operate in two modes:

1. Control by the supply air temperature sensor (TJ-K10K), when the first (1) switch of JP1 -(R37) (see Fig. 1 on page 4) is in position ON. LED 6 flashes twice per second. Set point temperature (0...30) °C.

2. Control by the supply (TJ-K10K) and by the room (NTC10) air temperature sensor, when the first (1) switch of JP1-(R37) (**see Fig. 1 on page 4**) is in position OFF. LED 6 flashes once per second. Setpoint temperature (15...30) °C. In this mode is preprogrammed the minimum (15°C) and the maximum (45°C) temperatures of supply air. The room air temperature sensor is mounted in the wired remote control panel TR5KNTC10.

Depending on the operating mode there can be set the different desired (setpoint) air temperature by wired remote control panel TR5KNTC10.

IMPORTANT: If failure appears, power supply must be switched off and only then performed fault elimination works.

* - non standart option. For more information please contact sales@ventmak.a.lt

Description of operating EKA NV ... PTC/2NTC*

Electrical duct heaters EKA NV ... PTC/2NTC are designed with integrated temperature control, PTC (air velocity) and two temperature sensors, potentiometer on the top of the heater casing for temperature setpoint.

When the heater power supply is switched on, controller (EKR-K) is in preparation mode for 30 seconds, LED 1 flashes once every 5 seconds. If air velocity is detected by PTC sensor (rapid LED 1 flashes when Min. 1,5 m/s is detected) after preparation mode ends, LED 1 will start to flash once every second and controller will initiate the heating based on demand, LED 2 is indicating when heating is initiated. If there is no air velocity detected, controller will not initiate the heating until air velocity detected.

Heaters EKA NV ... PTC/2NTC can operate in two modes:

1. Control by the supply air temperature sensor (TJ-K10K), when the first (1) switch of JP1-(R37) (**see Fig. 1 on page 4**) is in position OFF. LED 1 flashes once per second. Setpoint temperature (0...30) °C.

2. Control by the supply (TJ-K10K) and by the room (NTC10) air temperature sensor, when the first (1) switch of JP1-(R37) (**see Fig. 1 on page 4**) is in position ON. LED 1 flashes twice per second. Setpoint temperature (15...30) °C. In this mode is preprogrammed the minimum (15°C) and the maximum (40°C) temperatures of supply air. The room air temperature sensor is mounted in the wired panel TRNTC10.

Depending on the operating mode there can be set the different desired (setpoint) air temperature by potentiometer on the top of the heater casing.

IMPORTANT: If failure appears, power supply must be switched off and only then performed fault elimination works.

* - non standart option. For more information please contact sales@ventmak.a.lt

Description of operating EKA NI ... PTC/2NTC*

Electrical duct heaters EKA NI ... PTC/2NTC are designed with integrated temperature control, PTC (air velocity) and two temperature sensors, wired remote control panel (TR5KNTC10) for temperature setpoint.

When the heater power supply is switched on, controller (EKR-K...) is in preparation mode for 30 seconds, LED 1 flashes once every 5 seconds. If air velocity is detected by PTC sensor (rapid LED 1 flashes when Min. 1,5 m/s is detected) after preparation mode ends, LED 1 will start to flash once every second and controller will initiate the heating based on demand, LED 2 is indicating when heating is initiated. If there is no air velocity detected, controller will not initiate the heating until air velocity detected.

Heaters EKA NI ... PTC/2NTC can operate in two modes:

1. Control by the supply air temperature sensor (TJ-K10K), when the first (1) switch of JP1-(R37) (**see Fig. 1 on page 4**) is in position OFF. LED 1 flashes once per second. Set point temperature (0...30) °C.

2. Control by the supply (TJ-K10K) and by the room (NTC10) air temperature sensor, when the first (1) switch of JP1-(R37) (**see Fig. 1 on page 4**) is in position ON. LED 1 flashes twice per second. Setpoint temperature (15...30) °C. In this mode is preprogrammed the minimum (15°C) and the maximum (40°C) temperatures of supply air. The room air temperature sensor is mounted in the wired remote control panel TR5KNTC10.

Depending on the operating mode there can be set the different desired (setpoint) air temperature by wired remote control panel TR5KNTC10.

IMPORTANT: If failure appears, power supply must be switched off and only then performed fault elimination works.

* - non standart opon. For more information please contact sales@ventmak.a.lt

Service

No special service is required for electrical heaters, only to check electrical connection not less than 1 meter per year.

Troubleshooting

No heating from heater	<ol style="list-style-type: none"> 1. If the manual protection is activated, check for a fault before pressing the RESET button. If the fault is identified after it has been rectified, press the RESET button using a screwdriver or similar object. 2. No power supply to heater – check all external electrical connection components (relays, switches). 3. Temperature sensor fault. Check sensor resistance, it must be 10kΩ at 25°C. 4. Pressure switch fault. Check if pressure in system is set correctly (check the pressure when air flow is not less than 1,5m/s). 5. If LED 1 lights continuously it means that there is a failure of: PTC (air velocity) sensor, supply (TJ-K10K) or room (NTC10) air temperature sensor, potentiometer on the top of the heater casing, wired remote control panel TR5K. 6. When the heater power supply is switched on, after power supply interruption or after any failure, controller is in preparing mode for 30 seconds. 7. PCB fault. Contact: quality@ventmak.a.lt
Heater gives full output, not by set point	<ol style="list-style-type: none"> 1. Temperature sensor fault. Check sensor resistance, it must be 10kΩ at 25°C. 2. Air flow sensor fault. Check sensor resistance. It must be 22Ω between X15...X16 and 10Ω between X15...X18. Sensor must be clear. 3. When the heater power supply is switched on, after power supply interruption or after any failure, controller is in preparing mode for 30 seconds. 4. Triacs fault. Contact: quality@ventmak.a.lt 5. PCB fault. Contact: quality@ventmak.a.lt
Automatic circuit breaker switching off	<ol style="list-style-type: none"> 1. Check circuit breakers data, it must correspond to heaters electrical data. 2. Check isolation of connection cables, wires, check if heater grounded. 3. Check power supply source data, it must correspond to heaters electrical data.
Protection thermostat cut off	<ol style="list-style-type: none"> 1. Low air flow speed through heater. Check filters, fans, ducts of system. 2. Pressure switch fault. Check if pressure in system is set correctly (check the pressure when air flow is not less than 1,5m/s).

Warranty

1. Manufacturer declares **2 years** warranty term from the date of manufacturer's invoice. Warranty is applied in case if all requirements of transportation, storing, installation and electrical connection are fulfilled.

2. In case of damaged or faulty product during warranty term customer must inform producer in 5 days and deliver product to manufacturer as soon as possible at customer's costs. In other case warranty is not valid.

3. Manufacturer is not responsible for damages which occur during transportation or installation.



Manufacturer:

VENTMATIKA UAB

Metalistu str. 2A -1, 78107 Siauliai

Lithuania

EKA2020EN_002