



SILVERTOP®

15

Self-regulating and high efficiency (>90%) Heat Recovery Ventilation Compact Unit with high performance. Ecological solution®. Airflow to 00 m³/h





APPLICATION

- ▲ **SILVERTOP®** range is a PLUG&PLAY and a self-regulating Heat Recovery Ventilation unit with multilingual communication, for office and industrial applications.
- ▲ Efficiency over **90 %** (EN308), compliant with French **RT2012** regulation and with the **ErP 2009/125/EC** directive.
- Air filtration, temperature control, thermal comfort.
- ▲ One-piece monobloc unit, compact, top-mounted duct connectors, plug and play and interactive (except **SEASON** model).

RANGE

- With 6 available models, the **SILVERTOP®** range handles flow rates from 100 to 5 500 m³/h.

The **SILVERTOP®** range is available in 5 different regulation programs, all available with right access in the fresh air supply way:

SEASON : Design for temperate climate areas, provides air renewal with high efficient energy recovery. Summer/winter operating of the counter flow heat exchanger. Adjustable flow rates by potentiometer.

FIRST : Self-regulated unit for temperate climates, with active temperature management for optimal energy consumption and thermal comfort.

SMART: Idem **FIRST**, but equipped with a defrost electric battery which allows its use down to -20°C.

PREMIUM: Idem **FIRST**, but equipped either with a water coil (BC) or with an electric battery (BE) allowing its use down to -10°C.

INFINITE: Idem **PREMIUM** but as standard has a defrost electric battery for outdoor temperatures down to -20°C.

EQUIPMENT

- Double skin 10/10° outdoor panels.
- ▲ Insulation: 25mm high density A2-s1 (T3 and L2 class on casing airtightness as specified by EN1881) for models 06 and 08, 50mm high density M0 A1 mineral wool (T2 and L2 class on casing airtightness as specified by EN1886) for models 15, 23, 35 and 52.
- External side: RAL 7035 painted panels with a protective film.
- Internal side: Galvanized steel panels.
- ▲ Circular connectors with lip seals for airtightness guarantee (Equipped with circular branch connections with double lip seals to ensure network sealing ATEC CSTB n° 13-224-12), square connectors for model 52.
- Crimped feet integrated to the frame for handling and ground fixing.
- ▲ "EASY" technical board regroups all electrical components, potentiometer (for **SEASON** version) and control systems. Access by doors mounted on hinges for easy maintenance. Pad lockable switch and cable gland mounted on the top access panel.
- ▲ Top hydraulic connections (**PREMIUM BC** and **INFINITE BC** versions).
- Inclined condensate tray, easy removal.
- ▲ Condensate drain outlet on bottom of the unit.
- ▲ Filters and components access within lockable hinged doors.
- Monobloc version for all range.
- ▲ Phonic insulated panel on fresh air supply for a better acoustic comfort.

FANS

- ▲ Plug fans.
- ▲ Direct drive continuous current motors with electronic switching system (**EC**) high efficiency plug fan, with integrated thermal overload and variable speed protection. EC technology is an Econological® solution ensuring low energy consumption (French **RT2012** regulation compliant) with management, control and regulation of the operating point (flows rate selections from 10 up to 100%). Low Noise level for a better acoustic comfort.

ENERGY EXCHANGER

- Counterflow static high efficiency energy exchanger with aluminum plates. Air to air Exchanger produced by KLINGENBURG with an **EUROVENT** certification for the AAHE.



INTEGRATED EXCHANGER

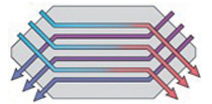

- ▲ Efficiency higher than 90 % (**EN 308**).
- Automatic defrost in chain reaction with proportional bypass opening first (except **SEASON** which has an all or nothing bypass), then self-regulating defrost electrical battery for **SMART** and **INFINITE** and finally eventual supply fresh air modulated airflow (except **SEASON**).

FILTERS

- ▲ As standard, the **SILVERTOP®** unit includes a high efficiency (large filtration surface) **F7** opacimeter filter for fresh air and a gravimetric **G4** for exhaust air.
- Air filters are always located upstream from the components for their protection.
- Mounted on slides for an easy replacement, fitted with draughtproof sealing ensuring efficient airtightness.
- Additional filters on fresh air available in option.

EQUIPMENT AND FUNCTIONNALLITY

- ▲ As standard **FIRST**, **SMART**, **PREMIUM** and **INFINITE** versions are equipped with an "EASY", regulation, with MODBUS, BACNET or WEB communication (selection on site). The **EASY** regulation integrates and matches the criteria of our **BLUETECH®** concept, offering an optimal running of the **SILVERTOP®** unit which fits all the French national (**RT2012**) and European (**ErP**) requirements and participates thanks to its efficiency to the active building management (**EN15232**).
- ▲ "EASY" regulation is integrated with an IP65 LCD display on the front panel. It's possible to add (OPTION) a touchscreen remote display with a user interface for main functions access (temperature control, reminders, errors...) and a maintenance interface giving access to the general parameters (remote distance up to 100 m).
- Internal timer ensuring dual flows operating, which are user programmable on site (except **SEASON**).
- Weekly and holiday period timer (except **SEASON**).
- ▲ Pressure controller detects dirty filter and notifies errors on display (volt free contact for **SEASON**). Timer function to be activated on site for planning filters replacement periods (except **SEASON**).
- Airflow pressure controller on each fan with errors displayed on the control panel (volt free contact for **SEASON**).
- ▲ Lockable padlock switch mounted on the top panel.
- ▲ **EASY** regulation (except **SEASON**) manages the optimal operating point and performance of the **SILVERTOP®** using the integrated temperature sensors:
 - Outdoor air sensor
 - Building ambient air sensor (on exhaust outlet)
 - Supplied fresh air sensor
 - Bypass defrost sensor
 - Defrost battery sensor (**SMART** and **INFINITE** versions)
- EASY** regulation enables optimal fresh air energy input and ensures the following Econological® functions:
 - **FREE COOLING**: In summer or mid-season, if the outdoor temperature is lower than the indoor temperature and the **SILVERTOP®** unit (except **SEASON**) is operating in a cooling mode, the exchanger bypass will slowly open to an adapted position until its full opening, in order to bring free cold outdoor air inside the building. If this operation is not enough to reach the temperature setpoint, the cooling mode will be activated.



- **FREE HEATING:** Mainly in mid-season, if the outdoor temperature is higher than the indoor temperature and the **SILVERTOP®** unit (except **SEASON**) is operating in a heating mode, the exchanger bypass will slowly open to an adapted position until its full opening, in order to bring free warm outdoor air inside the building. If this operation is not enough to reach the temperature setpoint, the heating mode will be activated.
- **COLD RECOVERY:** In summer or in mid-season, if the outdoor temperature is higher than the indoor temperature and the **SILVERTOP®** unit (except **SEASON**) is in a cooling mode, the exchanger bypass will slowly close to prevent the outdoor warm air from entering inside the building. If this operation is not enough to reach the temperature setpoint, the cooling mode will be activated. For the **SEASON**, version, the cold recovery mode will start when outdoor temperature gets higher than 24°C (adjustable).
- **HEAT RECOVERY:** In winter or in mid-season, if the outdoor temperature is lower than the indoor temperature and the **SILVERTOP** unit (except **SEASON**) is in a heating mode, the exchanger bypass will slowly close to prevent the outdoor cold air from entering directly inside the building. If this operation is not enough to reach the temperature setpoint, the heating mode will be activated. For the **SEASON**, version, the heat recovery mode will start when the outdoor temperature gets higher than 18°C (adjustable).
- **NIGHT COOLING:** The night cooling mode (except **SEASON**) enables to reduce the indoor building temperature depending on the last 24 hours climate conditions. Thereby between midnight and 7h (adjustable period) the night cooling function starts if the outdoor temperature is above 22°C (adjustable) during the day (between 6h and 22h). Night cooling mode is activated if the outdoor temperature is between 10 and 18°C (adjustable) and if the fresh air inlet is higher than 18°C (adjustable).
- ▲ Moreover, this function has a specific ventilation set point for the airflow modulation selected on the **FIRST** and **PREMIUM** versions offered by the **EASY** regulation.
- **FIRE SAFETY:** As standard, the **SILVERTOP®** unit (except **SEASON**) integrates a fire safety system managing the supply and extract air fans control, following 5 modes available in the regulation parameters (function to be activated on site).
 "Stop": Full Stop of the unit
 "Continuous Running": Starts or keeps the unit in high speed, the fire safety function will have the priority on other alarms.
 "Auto": Keeps the unit running with the settings entered on site (Stop/LS/HS).
 "Supply fan only": Starts or keeps the supply air fan in high speed (exhaust off).
 "Extract fan only": Starts or keeps the exhaust air fan in high speed (supply off).
 The **SILVERTOP®** unit also has a digital input "Remote run/stop" which enables connection with a manual remote control. In this

case, the external remote control has the priority on the fire security eventually activated on one of the five modes described above. Whatever mode chosen, the screen of the **EASY** regulation will show "fire security alarm" when this function is activated.

AIRFLOW MODULATION

- ▲ 6 choices of flow rate modulations for optimized energy consumption (**RT2012**, **EN15232**).
SEASON: Adjustment of each fan rotation speed by potentiometers mounted and connected in the control system board.
- For versions **FIRST**, **SMART**, **PREMIUM**, and **INFINITE**, the **EASY** regulation can control the fans in the following modes:
ECO: Fans speed adjustment through 2 airflow settings (LS-HS) in the **EASY** regulation.
LOBBY®: Airflow rate modulation with **CONSTANT PRESSURE** mode, adjustable for each fan.
DIVA®: Proportional modulation of each fan airflow depending on the CO2 rate. CO2 sensor integrated in the exhaust air inlet.
MAC2®: Modulation in **CONSTANT AIRFLOW** for each fan (LS and HS) (except sizes 06 and 08). Pressure transmitters integrated inside the unit.
QUATTRO®: Proportional modulation in **CONSTANT AIRFLOW** for each fan depending on the CO2 rate (except sizes 06 and 08). Pressure transmitters and CO2 sensor (exhaust air inlet) integrated in the unit. Settings of the LS, the HS and the CO2 minimum rate (ppm) adjustable on site directly on the **EASY** regulation.

INSTALLATION

- ▲ Indoor.
- ▲ Compact design and small footprint, top connections via double lips circular connectors (except size 52) for an easy, quick, airtight and cost-efficient installation (no adapters).

CLIMATIC VERSIONS

- ▲ The **SILVERTOP®** unit is available in **FIRST** and **SEASON** versions for winter use down to -5°C. It is also available in **PREMIUM BC** (water heating integrated coil) and **PREMIUM BE** (electric integrated heater) offering optimal winter use down to -10°C. Lastly, its **SMART** version (electrical defrost) **INFINITE BC** (integrated electrical defrost heater and heating water coil battery) and **INFINITE BE** (integrated electrical defrost heater and electrical heating battery) is designed for an optimal winter use down to -20°C. Their functionalities are managed by the "**EASY**" regulation.
- ▲ Furthermore, for an optimal all seasons and all climates comfort, **SILVERTOP®** unit can be connected to a water or a direct expansion cooling module (except **SEASON**) or even to a dehumidification module (**FIRST** or **SMART**): The "**EASY**" regulation integrated to the **SILVERTOP®** unit enables compatible thermal modules management.

VERSIONS	INTEGRATED THERMAL BATTERY			EXTERNAL MODULE								
	DEFROST	HEATING		HEATING		COOLING		DEHUMIDIFICATION Cooling + Heating				
	Electrical	Electrical	Water	Electrical	Water	Water	R410A	Water/Water	Water/Elec	R410A/Water	R410A/Elec	
SEASON	-	-	-	-	-	-	-	-	-	-	-	-
FIRST	-	-	-	CBX-BE + CAB-CBE	CBX-BC	CBX-BF	CBX-DX	CBX-CH	CBX-CE + CAB-CBE	CBX-DXH	CBX-DXE + CAB-CBE	
SMART	✓	-	-	CBX-BE + CAB-CBE	CBX-BC	CBX-BF	CBX-DX	CBX-CH	CBX-CE + CAB-CBE	CBX-DXH	CBX-DXE + CAB-CBE	
PREMIUM BE	-	✓	-	-	-	CBX-BF	CBX-DX	-	-	-	-	-
PREMIUM BC	-	-	✓	-	-	CBX-BF	CBX-DX	-	-	-	-	-
INFINITE BE	✓	✓	-	-	-	CBX-BF	CBX-DX	-	-	-	-	-
INFINITE BC	✓	-	✓	-	-	CBX-BF	CBX-DX	-	-	-	-	-

- ▲ Dehumidification function (to be activated on site) associates a COMBIBOX CONCEPT® module with both cooling and heating functions (Water or R410A) and also a heating module (Water or electrical) for **FIRST** or **SMART** version, to the **SILVERTOP®**. In this

case, the regulation will automatically manage heating and cooling needed supply for dehumidification while providing the optimum temperature to the building. During cooling demand, building temperature management has the priority over dehumidification.



SILVERTOP® Model	Electrical motor power (W)	Temp. Use (°C / °C)	Electrical safety rating	Thermic protection *	SEASON, FIRST & PREMIUM BC		INFINITE BC & SMART		PREMIUM BE		INFINITE BE	
					Electrical supply voltage (V / Ph / Hz)	Electric charge protection (A)	Electrical supply voltage (V / Ph / Hz)	Electric charge protection (A)	Electrical supply voltage (V / Ph / Hz)	Electric charge protection (A)	Electrical supply voltage (V / Ph / Hz)	Electric charge protection (A)
15	2x480 W	-20/40	IP54/B	PTI	230/1/50	4,9	400/3+N/50	9,7	230/1/50	21,2	400/3+N/50	15,1

* PTI: Included Thermic Protection

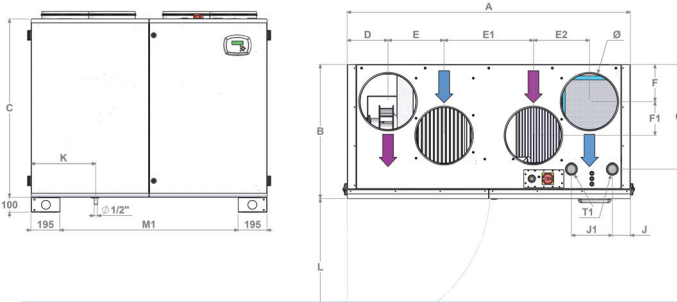

DIMENSION CHARACTERISTICS SILVERTOP®

SILVERTOP® Model	Ø	A	B	C	D	D1	D2	E	E1	E2	F	F1	G	J	J1	K	L	M1	M2	M3	T1	SEASON FIRST	PREMIUM BE SMART PREMIUM BC	INFINITE BE INFINITE BC
	mm	mm	mm	mm	mm	mm	mm	mm	mm	mm	mm	mm	mm	mm	mm	mm	mm	mm	mm	mm	mm	kg	kg	kg
15	315	1590	750	1200	230	-	-	315	500	315	210	190	585	100	230	435	770	1200	-	-	1/2"	320	330	335

G - J - J1 - T1 for Water Coils battery (PREMIUM BC / INFINITE BC) (T1= Gas threaded steel pipe diameter)

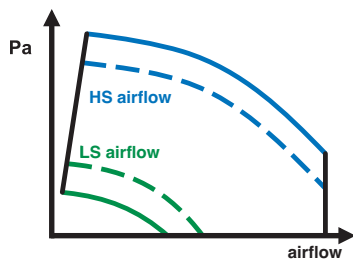

SILVERTOP® ECO Operating

Selection of 1 or 2 different airflows (LS/HS) per fan. Except for SEASON, 1 airflow adjustable with potentiometer

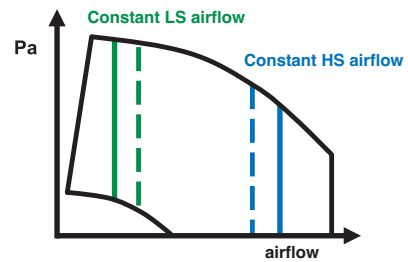

SILVERTOP® + MAC2 Operating

Selection of 1 or 2 CONSTANT airflows per fan, except for SILVERTOP® 06 and 08.

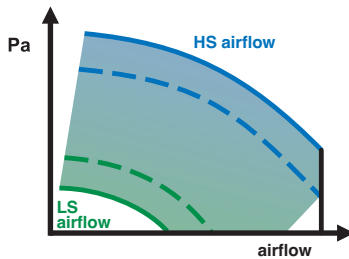

SILVERTOP® + DIVA® Operating

PROPORTIONAL ventilation between two airflows (LS/HS) per fan.

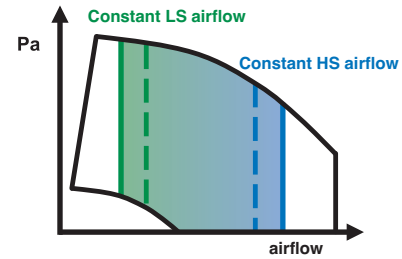

SILVERTOP® + QUATTRO® Operation

PROPORTIONAL ventilation between two CONSTANT airflows per fan. Except for SILVERTOP® 06 and 08.

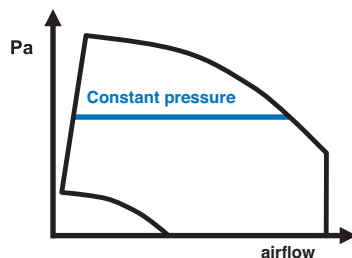

SILVERTOP® + LOBBY® Operating

CONSTANT PRESSURE ventilation per fan



ED-TOUCH LCD display
(no compatible with SEASON version)
With user display and maintenance interface
(up to 100 m)



- The L_{p4m} dB(A) curves correspond to the level of acoustic pressure at 4m in a hemispherical free field on a reflective plane, the "supply to room" and "exhaust to outside" sides not connected, the "supply to room" and "exhaust from room" connected.
- To achieve the overall acoustic pressure L_p dB(A), at a certain distance, add the values below to L_{p4m} .

Distance (m)	1,5	3	4	5	7	10
Distance weighting dB(A)	9	3	0	-2	-5	-8

Tolerances: Global values
 +/- 3 dB(A)
 Acoustic Spectrum
 +/-5 dB(A)

- The curves for "Lw duct supply to room dB(A)" correspond to the overall acoustic power emitted on the "supply to room" side or "exhaust to outside".
- To achieve the range of acoustic power "Lw duct supply to room dB(A)", on the "supply to room" or "supply to room", add the below values to the acoustic power "Lw duct supply to room" displayed on the curves.

Downstream acoustic spectrum weighting function "Lw duct supply to room dB(A)" displayed on the curves								
Frequency	63 Hz	125 Hz	250 Hz	500 Hz	1000 Hz	2000 Hz	4000 Hz	8000 Hz
SILVERTOP 15 weighting dB(A)	-21	-11	-6	-8	-6	-9	-14	-19

- The curves for "Lw duct exhaust from room dB(A)" correspond to the overall acoustic power emitted on the duct sides "exhaust from room" and "exhaust from room".
- To achieve the range of acoustic power "Lw duct exhaust from room", on the "exhaust from room" and "intake from outside" sides, add the values below to the acoustic power "Lw duct exhaust from room" displayed on the curves.

Upstream acoustic spectrum weighting function "Lw duct exhaust from room" displayed on the curves								
Frequency	63 Hz	125 Hz	250 Hz	500 Hz	1000 Hz	2000 Hz	4000 Hz	8000 Hz
SILVERTOP 15 weighting dB(A)	-20	-14	-7	-6	-6	-8	-14	-22

- To achieve the acoustic pressure NSC4 dB(A) (noise level at 4m in a hemispherical free field, with the device placed on the ground on a reflective plane, with HRV terminals connected to the intake and discharge with ducts having same level of sound insulation), add following values to L_{p4m} value displayed on the curves.

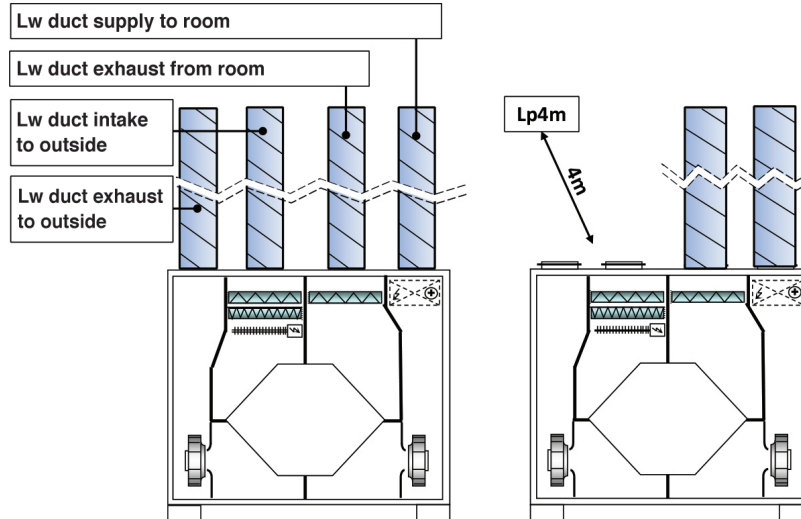

PERFORMANCE LABELLING

Products with this label do respect Uniclimate's recommendation for performances labelling.

NOTA:

Curves are issued from measurements, on the fresh air, made with all ducts connected (configuration D description from EN 13141-4).



EQUIPEMENTS	SEASON	FIRST	SMART	PREMIUM BE	PREMIUM BC	INFINITE BE	INFINITE BC
Low energy consumption EC Fan motors	●	●	●	●	●	●	●
Opacimetric F7, fresh air filter	●	●	●	●	●	●	●
Gravimetric G4, exhaust air filter	●	●	●	●	●	●	●
High efficiency plate conterflow exchanger (>90%) EUROVENT certified	●	●	●	●	●	●	●
Internal 100% Bypass	●	●	●	●	●	●	●
Removable inclined condensate trays below plate conterflow exchanger	●	●	●	●	●	●	●
RAL7035 double skin panels 50 mm insulation (except 06 & 08 : 25mm)	●	●	●	●	●	●	●
Circular branch connectors with double lip seal (ATEC CSTB n°13-224-12), except 52, square connectors	●	●	●	●	●	●	●
IP65 LCD display included on the front panel	-	●	●	●	●	●	●
MODBUS or BACNET in RS485 or TCP/IP or WEB (selection on menu) communicating regulation	-	●	●	●	●	●	●
Fans speed control (LS - HS) with EASY regulation	-	●	●	●	●	●	●
Fan rotation speed control through potentiometer	●	-	-	-	-	-	-
Supply temperature sensor	-	●	●	●	●	●	●
Exhaust temperature sensor	-	●	●	●	●	●	●
Outdoors temperature sensor	●	●	●	●	●	●	●
Bypass defrost temperature sensor	-	●	●	●	●	●	●
Defrost battery sensor	-	-	●	-	-	●	●
Antifreezing thermostat on heating battery	-	-	-	-	●	-	●
Defrost electric battery thermostat	-	-	●	-	-	●	●
Heating Electric battery thermostat	-	-	-	●	-	●	-
Lockable proximity switch	●	●	●	●	●	●	●
Electric wire pass-through	●	●	●	●	●	●	●
FUNCTIONS	SEASON	FIRST	SMART	PREMIUM BE	PREMIUM BC	INFINITE BE	INFINITE BC
Defrost through bypass	●	-	-	-	-	-	-
Cascade defrost : bypass + battery(SMART/INFINITE) + fresh air airflow modulation	-	●	●	●	●	●	●
Self-regulating electric defrost battery	-	-	●	-	-	●	●
Self regulating heating battery	-	-	-	●	-	●	-
Self regulating water coils battery	-	-	-	-	●	-	●
Internal 100%, All or Nothing, Automatic management Summer/Winter	●	-	-	-	-	-	-
Internal 100% bypass, self-regulating and modulating (0-100%)	-	●	●	●	●	●	●
Free-Cooling optimal management	-	●	●	●	●	●	●
Free-Heating optimal management	-	●	●	●	●	●	●
Nigth-Cooling managment (night boost ventilation)	-	●	●	●	●	●	●
Optimum cooling recovery management	-	●	●	●	●	●	●
Thermostatic cooling recovery management	●	-	-	-	-	-	-
Optimum heat recovery management	-	●	●	●	●	●	●
Thermostatic heat recovery management	●	-	-	-	-	-	-
Supply temperature management (Air law)	-	●	●	●	●	●	●
Building temperature management (exhaust)	-	●	●	●	●	●	●
Weekly timer	-	●	●	●	●	●	●
Holidays and bank holidays timer	-	●	●	●	●	●	●
Fresh air pressure switch	●	●	●	●	●	●	●
Airflow control pressure switch (exhaust and supply)	●	●	●	●	●	●	●
Fire security with 5 available modes	-	●	●	●	●	●	●
Heating management module (electric or water) COMBIBOX CONCEPT®	-	●	●	-	-	-	-
Cooling management module (water or R410A) COMBIBOX CONCEPT®	-	●	●	●	●	●	●
Dehumidification module COMBIBOX CONCEPT®	-	●	●	-	-	-	-
FACTORY MOUNTED OPTIONS	SEASON	FIRST	SMART	PREMIUM BE	PREMIUM BC	INFINITE BE	INFINITE BC
LOBBY® : airflow modulation with CONSTANCE PRESSURE	-	○	○	○	○	○	○
DIVA®: proportional airflow modulation based on CO2	-	○	○	○	○	○	○
MAC2®: airflow modulation at CONSTANT AIRFLOW (except SILVERTOP 06 and 08)	-	○	○	○	○	○	○
QUATTRO®: proportional airflow modulation base on CO2 between 2 CONSTANT AIRFLOWS (except SILVERTOP 06 and 08)	-	○	○	○	○	○	○
OPTIONAL EQUIPMENT (Supplied unassembled)	SEASON	FIRST	SMART	PREMIUM BE	PREMIUM BC	INFINITE BE	INFINITE BC
Cooling module (water or R410A) COMBIBOX CONCEPT®	-	◆	◆	◆	◆	◆	◆
Heating module (electric or water) COMBIBOX CONCEPT®	-	◆	◆	-	-	-	-
Dehumidification module COMBIBOX CONCEPT®	-	◆	◆	-	-	-	-
Changeover pad for heating/cooling switch on changover battery (Supplementary module)	-	◆	◆	-	-	-	-
LON network communication	-	◆	◆	◆	◆	◆	◆
Touchscreen remote control (up to 100 m)	-	◆	◆	◆	◆	◆	◆
Ambient Temperature management via LCD remote control	-	◆	◆	◆	◆	◆	◆
WONDEROOM®, area airflow and temperature management with self-communication with the SILVERTOP®	-	◆	◆	◆	◆	◆	◆
Exhaust filter pressure switch	◆	◆	◆	◆	◆	◆	◆
Fresh air prefilter, gravimetric or opacimetric (G4 or M5)	◆	◆	◆	◆	◆	◆	◆
Fresh air filter, opacimetric F9	◆	◆	◆	◆	◆	◆	◆
Exhaust filter, opacimetric M5	◆	◆	◆	◆	◆	◆	◆

● : Standard equipment or function ○ Optional equipment or function. Factory cabled and mounted.
◆ : Optional equipment or function. Supplied unassembled

SILVERTOP® 15

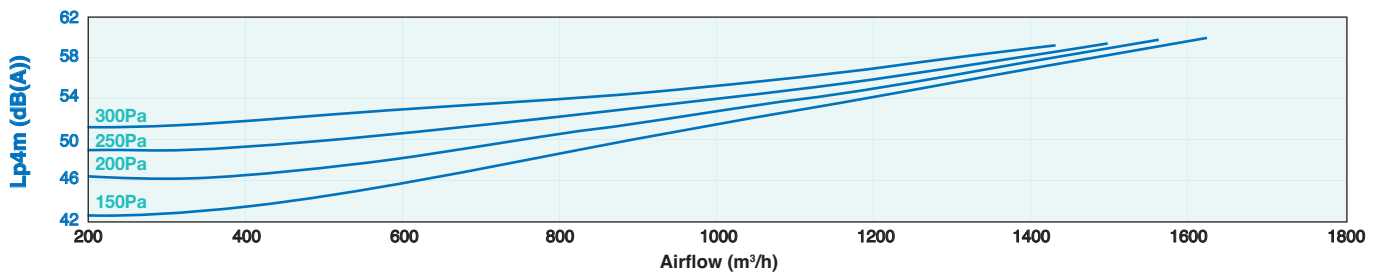
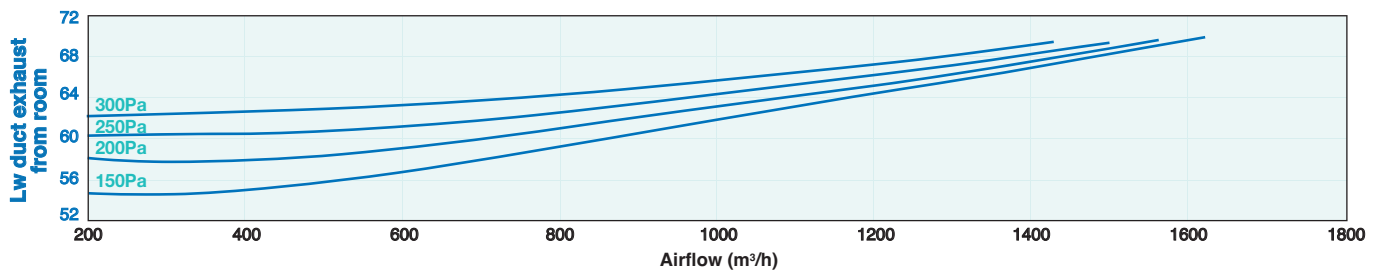
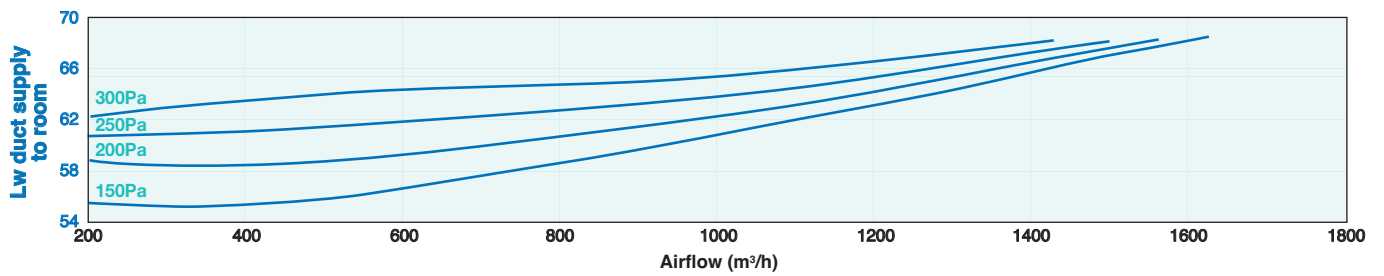
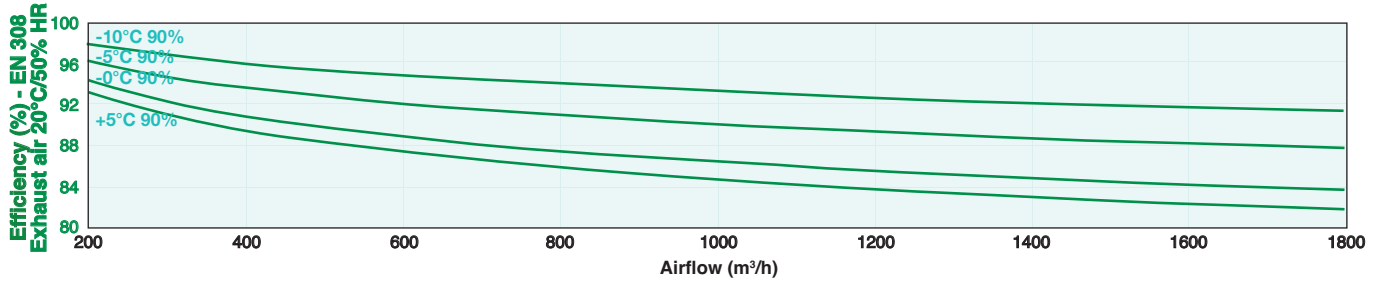
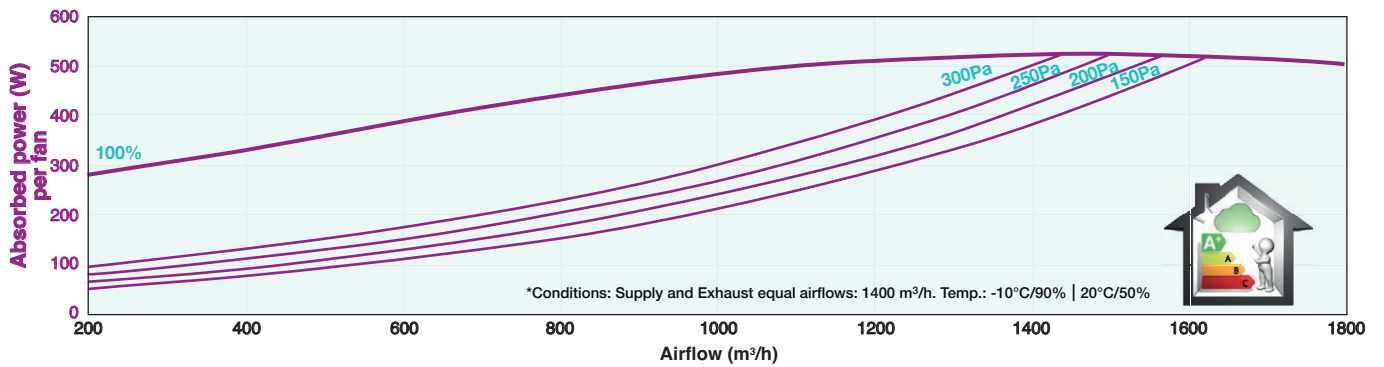
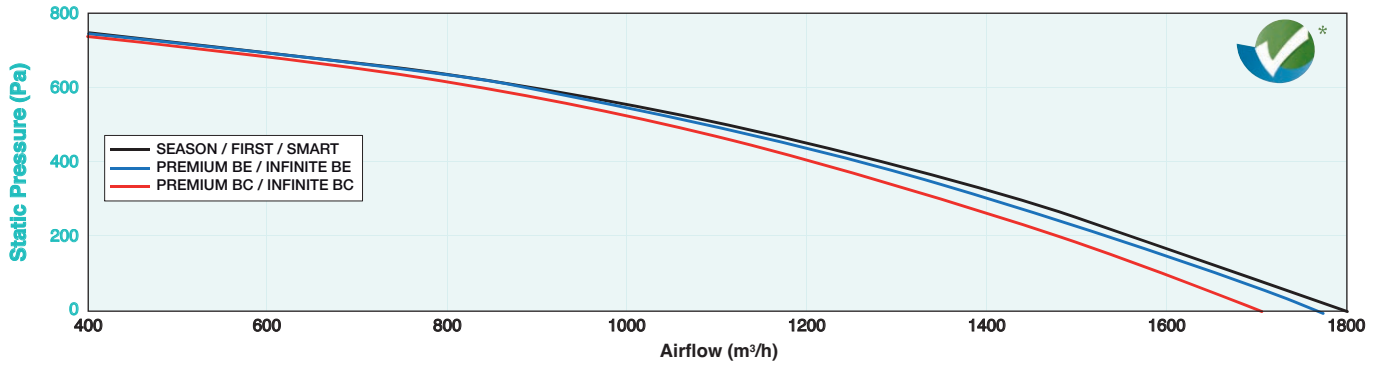



SILVERTOP® 15

Heating water coil battery - PREMIUM / INFINITE BC

Version	Airflow (m³/h)	500	700	900	1100	1300	1500	1700
80/60	11	Power [kW]/Air outlet Temp. [°C] 6,4 / 48,6	8,0 / 44,6	9,4 / 41,7	10,7 / 39,4	11,8 / 37,5	12,8 / 36,0	13,7 / 34,6
		Water flow [l/h]/DP water [kPa] 281 / 1,9	352 / 2,9	413 / 3,9	467 / 4,9	516 / 5,8	561 / 6,8	601 / 7,7
15	11	Power [kW]/Air outlet Temp. [°C] 6,0 / 49,9	7,5 / 46,2	8,8 / 43,5	9,9 / 41,3	10,9 / 39,6	11,9 / 38,1	12,7 / 36,9
		Water flow [l/h]/DP water [kPa] 261 / 1,7	327 / 2,5	384 / 3,4	434 / 4,2	479 / 5,1	520 / 5,9	558 / 6,7
60/50	11	Power [kW]/Air outlet Temp. [°C] 4,8 / 39,2	6,1 / 36,3	7,1 / 34,2	8,1 / 32,5	8,9 / 31,1	9,7 / 29,9	10,4 / 29,0
		Water flow [l/h]/DP water [kPa] 419 / 4,1	527 / 6,3	620 / 8,5	702 / 10,7	777 / 12,9	845 / 15,1	907 / 17,2
15	11	Power [kW]/Air outlet Temp. [°C] 4,4 / 40,6	5,5 / 37,9	6,5 / 36,0	7,3 / 34,4	8,1 / 33,2	8,8 / 32,1	9,4 / 31,2
		Water flow [l/h]/DP water [kPa] 380 / 3,5	477 / 5,3	561 / 7,1	636 / 8,9	703 / 10,7	764 / 12,5	821 / 14,3
45/40	11	Power [kW]/Air outlet Temp. [°C] 3,5 / 31,2	4,4 / 29,2	5,1 / 27,7	5,8 / 26,5	6,5 / 25,5	7,0 / 24,7	7,6 / 24,0
		Water flow [l/h]/DP water [kPa] 599 / 8,3	755 / 12,7	889 / 17,2	1009 / 21,7	1118 / 26,2	1217 / 30,6	1308 / 35,0
15	11	Power [kW]/Air outlet Temp. [°C] 3,0 / 32,6	3,8 / 30,8	4,5 / 29,5	5,1 / 28,5	5,6 / 27,6	6,1 / 26,9	6,6 / 26,3
		Water flow [l/h]/DP water [kPa] 521 / 6,4	656 / 9,8	773 / 13,3	876 / 16,7	970 / 20,2	1056 / 23,6	1134 / 26,9

SILVERTOP® 15

Electrical battery - SMART / PREMIUM / INFINITE BE

Fresh Air Airflow (m³/h)	0°C	-5°C	-10°C	-15°C	-15°C*	-0°C	-5°C	-10°C	-10°C*	-10°C	-15°C	-15°C*
	1500	1500	1500	1500	1500	1500	1500	1500	1500	1500	1500	1500
Version	FIRST-SEASON		SMART			PREMIUM BE			INFINITE BE			
			Defrost battery			Heating battery			Heating + Defrost batteries			
Power (kW)	-		5,25			3,75			5,25 + 3,75			
Unit outlet Temp. (°C)	16,9	16,6	16,9	17,1	18,3	24,4	24,1	20,1	27,6	24,4	24,6	27,7

Those datas result from optimum regulation configuration considering outdoor temperatures.
 Permanent unit supplied temperature, taking in account proportional bypass opening for exchanger defrost.
 * 20% Airflow decrease on FRESH AIR SUPPLY (As standard function)

For your external cooling batteries (water or R410A), use our selection software **SOFTWAIR®** and get the right selection with its detailed report.



**• SECURITY AND CONTROL****PRESSURE SWITCH**
ref. DEP

Exhaust air filter (IP54)

**MANOMETER WITH LIQUID**
ref. MANO**SMOKE DETECTOR**
ref. CDAD

(IP54) Cabinet

**BOXE RELEASE**
ref. BDTBTS 24 ou 48Vcc -
BOITIER (IP67)**• INSTALLATION****FLEXIBLE SLEEVE** ref. MTS M0Fire rated: M0
Male Diameter (ducts side) / Female (unit side)**• REGULATION****MONOFUNCTION AERA AIRFLOW MODULATOR** ref. SYSTEM TOP

All Or Few area airflow modulator. To be associated to LOBBY® (constant pressure). Airflow modulation versions.

**MONOFUNCTION AREA AIRFLOW MODULATOR** ref. SYSTEM DIVA

Modulating area airflow modulator. To be associated to LOBBY® (constant pressure). Airflow modulation versions

**MULTIFONCTIONS AREA AIRFLOW MODULATOR** ref. WONDEROOM

To be associated to LOBBY® (constant pressure). Airflow modulation versions. It handles area airflow modulation and communicates with the SILVERTOP® unit. Example for free-cooling / night-cooling.

**TOUCHSCREEN REMOTE CONTROL** ref. EDTOUCH

SEASON version isn't compatible.

• AIRFLOW MODULATION**REMOTE CONTROL**
ref. POT 230

Potentiometer only for SEASON version (IP54)

**COMFORT REMONTE CONTROL**
ref. CDC1V2

ON/OFF 2 fans - IP54 BOX

**COMFORT REMONTE CONTROL**
ref. CDC2V2

OFF/LS/HS 2 fans - IP54 BOX

**COMFORT REMONTE CONTROL**
ref. CDC PVGV2

LS/HS 2 fans - IP54 BOX

**PRESENCE DETECTOR**
ref. 360 TOR SAON/OFF or LS/HS
(no compatible with SEASON version)**• THERMAL****THERMOSTAT REVERSER**
SUMMER/WINTER
ref. PASTILLE CHANGEOVER

For FIRST and SMART versions connected with an external COMBIBOX CONCEPT® module

**HUMIDITY SENSOR**
ref. HR 010 SG

0-10V signal (no compatible with SEASON version)

**HUMIDITY SENSOR**
ref. HR 010 SA

0-10V signal (no compatible with SEASON version)

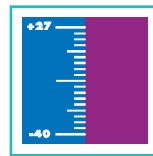
**DESHUMIDIFYING**
ref. CBX --

To be duct mounted (cf. Air Treatment chapter for details). No compatible with SEASON version

**CIRCULAR DAMPER**
ref. RC4A

Defrost security. Airtightness rate 3 (Ø200 à 500)

**ELECTROVALVE KIT** ref. KEI IP44

PREMIUM BC and INFINITE BC Versions Indoor Installation

Type 15/1.6-3/8" M for SILVERTOP 06/08
Type 15/2.5-1/2" M for SILVERTOP 15/23
Type 15/4-1/2" F for SILVERTOP 35
Type 20/6.3-3/4" F for SILVERTOP 52