



NEOTIME[®]

RANGE

Counter-flow, self-regulating, very high efficiency (90%), high yield, super slim, double flux station. Ecological[®] solution. Flow rate 100 to 2400 m³/h





APPLICATION

- ▲ Ventilation and energy recovery self-regulating, with very high energy efficiency and

yield for tertiary and industrial installations.

- ▲ Yields greater than **90 %** (EN308), in accordance with the **RT2012** and directive **ErP 2009/125/EC**.

- Air filtration, temperature control.
- ▲ Monobloc, compact, super slim, plug and play and networked station (except the SEASON version).

RANGE

- Available in 5 models, the **NEOTIME®** range covers flow rates from 100 to 2400 m³/h.

The **NEOTIME®** range is on offer with 5 finishes:

SEASON : a station for use in a temperate climate, designed for building air renewal and energy recovery, summer/ winter functioning of the bypass, adjustment of flow rates through the potentiometer.

FIRST : self-regulating station for use in a temperate climate and the active management of temperatures for the optimisation of energy consumption and climatic control.

SMART : Identical to FIRST with a compensating electric defrosting battery for external temperatures as low as -20°C.

PREMIUM : Identical to FIRST but equipped with either a changeover water battery (CO), or an electric battery (BE) for external temperatures of as low as -10°C.

INFINITE : identical finish to PREMIUM with an electric defrosting battery as standard for exterior temperatures as low as -20°C.

COMPOSITION

- 10/10° double-skin panels.
- ▲ Insulation: 25 mm, A2-S1, M0 high density mineral wool (Class T3 and L1 for envelope air-tightness in accordance with EN1886).
- External face: RAL 7035 prelacquered metal with protective film.
- Internal face: galvanised steel.
- ▲ Circular branch connections with lip seals to guarantee networks remain airtight (ATEC CSTB n° 13-224-12).
- Crimped brackets as part of the structure to enable roof mounting.
- ▲ “**EASY**” technical compartment grouping the electrical and regulating components. Access via an opening panel straightforward maintenance. Fixed panel integrating the series proximity switch, the potentiometers (SEASON version) and the power cord grommet.
- ▲ Filter access via access hatches and via removable panels for the other interior elements.
- Inclined and removable condensate tray for the evacuation of condensates where stations are assembled without an incline.
- ▲ **100% internal**, motorised and self-regulating, air regulation **RT2012**, bypass, except **SEASON** (summer/ winter management via thermostat and all/ nothing opening).

FAN MOTORS

- ▲ Direct drive, continuous current motorised fans with high yield electric commutation (**EC**) and integrated heat and speed variation protection. **EC** EC technology is an economical® solution guaranteeing low energy consumption (**RT2012**) for the management, control and command of the point of functioning (regulation of flow rates from 10 to 100%). Low noise levels for superior acoustic comfort.

EXCHANGER

- High efficiency, **counter-flow** static exchanger with aluminium plates. Air exchangers - air products by KLINGENBURG which participates in the **Eurovent** certification programme for AAHE.
- ▲ Efficiency greater than 90% (**EN 308**).
- Automatic, sequenced defrosting through the proportional opening of the bypass (except **SEASON**, All or Nothing) then via the electric, self-regulating defrosting battery for the **SMART** and **INFINITE** versions and lastly through eventual modulation of the new air flow rate (except **SEASON**).

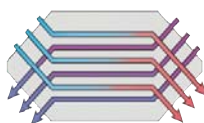

FILTERS

- ▲ As standard, the **NEOTIME®** station features an F7, high efficiency opacimetric filter (large filter surface) for new air and a G4 gravimetric filter for extracted air.

- Relative to the components, filters are always mounted upstream in order to ensure protection.
- Mounted on slide rails for straightforward replacement.

EQUIPMENT AND FUNCTIONS

- ▲ The **FIRST SMART, PREMIUM** and **INFINITE** versions are fitted as Standard with “**EASY**”, regulation, networked on MODBUS, BACNET or WEB (choice of language activated on the website). It integrates an LCD, remote control function (100m to 1km with repeater). The possibility (option) of completing the “**EASY**” regulation with a touch activated remote control, with a user interface and screen for the main functions (temperature control, restart, fault...) as well as a maintenance interface enabling access to general parameters (command panel works from a distance of 100m).

- ▲ **100% bypass**, built-in to the station, fitted with servomotors that are automatically guided by integrated regulation ensuring the **FREE-COOLING** and **NIGHT-COOLING** functions (nighttime over-ventilation with adjustable flow rate).

For the **SEASON** version the **100% Bypass** ensures summer/ winter management in All or Nothing mode via integrated thermostats.

- ▲ 4 choices of flow rate modulation to guarantee optimal energy consumption (RT2012, EN15232).

SEASON: Rotation speed adjustment for each fan via potentiometers mounted and wired to the facade of the regulation compartment.

ECO: Rotation speed adjustment for each fan via modification of the two flow rates (PV-GV) in **EASY** regulation.

LOBBY®: air flow modulation at CONSTANT PRESSURE, adjustable

For each fan (**FIRST, SMART, PREMIUM** and **INFINITE**).

DIVA®: Proportional modulation of the flow rate of each fan relative to the CO₂ level. Sensor built in to the station intake (**FIRST, SMART, PREMIUM** and **INFINITE**).

- Internal timers ensuring the programmable, two flow rate functioning chosen on the website (except SEASON).
- Weekly timer and timer for holidays and public holidays (except SEASON).
- ▲ The pressure switch filters new with default return air on command (dry contact for SEASON).
- The pressure switch controls the air flow for each fan with default return on the command panel (dry contact for SEASON).
- ▲ A proximity switch mounted on the unit facade.
- ▲ **Fire safety** function (except **SEASON**) enabling control of the output and intake fans in 5 available modes Within regulation parameters (function activated on the website). An alarm will then be displayed on the screen “Fire alarm”:

“Shutdown”: Complete station shutdown.

“Active” Activation or continued operation of the station at High Speed. The fire function will take priority in the event of any other alarm.

“Auto”: Continued station operation in accordance with site configuration (Shutdown/ Low Speed/ High Speed).

“Output active”: Activation or continued high speed operation of the output ventilator (intake in shutdown).

“Intake active” Activation or continued high speed operation of the intake fan (output in shutdown).

For that, the **NEOTIME®** station features the digital input “External Shutdown” In this case, the external command takes priority over fire safety if subsequently activated by any of the 5 modes below.

INSTALLATION

- ▲ Concealed behind a false ceiling.
- ▲ Direct access to the electrical cabinet and filters.

CLIMATE VERSIONS

- ▲ The **NEOTIME®** station offers a number of versions enabling guaranteed, optimal climate control (except SEASON). These functions are automatically managed via “**EASY**”. regulation. Water or electric batteries are integrated into the station and the associated temperature sensors are mounted, wired and factory tested so that the **NEOTIME®** is a true “**PLUG& PLAY**” station: Temperature sensors (x4) integrated into the station: output, intake, bypass defrosting, external temp. and for **SMART** and **INFINITE** versions there is a sensor for the defrosting battery.
- Built in frost protection thermostat (THA) ensuring the protection of the cooling battery in **PREMIUM/INFINITE CO** versions.
- A built-in, manually reset safety thermostat (THS) ensuring the protection of the electric defrost and heating batteries for **SMART, PREMIUM BE** and **INFINITE BE** versions.



Versions	INTEGRATED THERMAL BATTERY				EXTERNAL MODULE					
	DEFROSTING	HEATER		CHANGEOVER Warm/cold	REFRESH Cold Only		DEHUMIDIFYING Cold + Warm			
	Electric	Electric	water	water	water	R410A	Eau/Eau	water/Elec	R410A/water	R410A/ELEC
SEASON	-	-	-	-	-	-	-	-	-	-
FIRST	-	-	-	-	CBX-BF	CBX-DX	CBX-FH	CBX-FE	CBX-DXH	CBX-DXE
SMART	✓	-	-	-	CBX-BF	CBX-DX	CBX-FH	CBX-FE	CBX-DXH	CBX-DXE
PREMIUM BE	-	✓	-	-	CBX-BF	CBX-DX	-	-	-	-
PREMIUM CO	-	-	✓	✓	standard	CBX-DX	NEOTIME/CBX-BC	NEOTIME/CBX-BE	-	-
INFINITE BE	✓	✓	-	-	CBX-BF	CBX-DX	-	-	-	-
INFINITE CO	✓	-	✓	✓	standard	CBX-DX	NEOTIME/CBX-BC	NEOTIME/CBX-BE	-	-

▲ The dehumidification function (can be activated on the website) consists of associating a COMBIBOX CONCEPT® module with the NEOTIME® station fitted with a heating battery (water or single cold DX) followed by a cooling battery (water or electric). In this case the

regulator will automatically manage the cooling or warming effect necessary for dehumidification while maintaining an optimal functioning temperature. During a period of where cold is requested, temperature management takes priority over of dehumidification

DIMENSIONS CHARACTERISTICS

NEOTIME®

NEOTIME® model	Ø	A	B	C	D	E	F1	F2	F3	G	G1	G2	J	K	M	M1	M2	M3	T	T1	SEASON	FIRST SMART	PREMIUM BE INFINIT BE	PREMIUM CO INFINIT CO
	mm	mm	mm	mm	mm	mm	mm	mm	mm	mm	mm	mm	mm	mm	mm	mm	mm	mm	mm	mm	Kg	Kg	Kg	Kg
600	250	1700	780	330	160	370	-	-	-	150	50	145	170	645	640	-	-	-	1/2"	1/2"	120	127	130	135
900	315	2020	965	415	210	460	-	-	-	150	50	145	250	780	750	-	-	-	1/2"	1/2"	180	190	195	200
1300	355	2190	1220	415	190	600	795	735	660	430	50	425	250	880	950	1170	510	510	1/2"	1/2"	255	265	270	275
1800	400	2275	1220	495	245	600	915	725	635	430	50	425	330	885	950	1115	580	580	1/2"	1/2"	275	285	290	295
2500	400	2395	1740	495	235	910	840	785	770	430	50	425	330	985	1350	1235	580	580	3/4"	1/2"	380	390	400	405

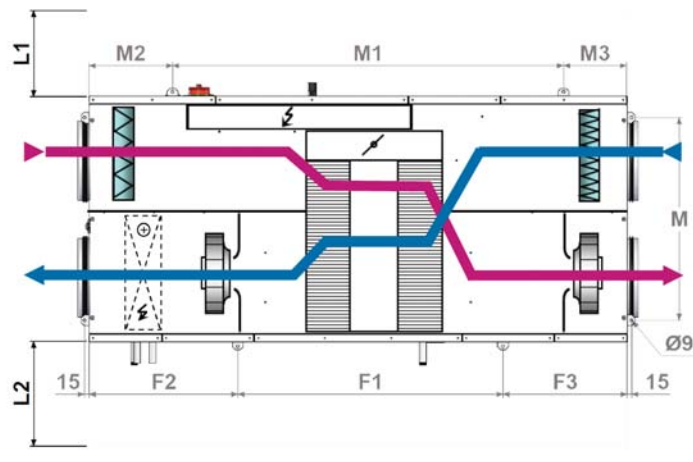
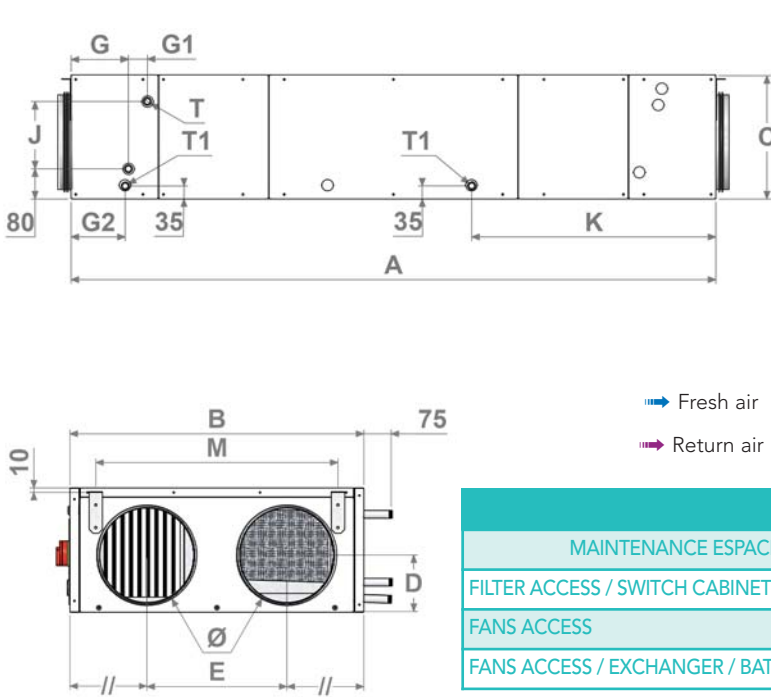

NEOTIME®						
MAINTENANCE ESPACE (mm)		600	900	1300	1800	2500
FILTER ACCESS / SWITCH CABINET	L1	275	375	520	520	690
FANS ACCESS	L2	225	320	380	435	435
FANS ACCESS / EXCHANGER / BATTERY CO	L2	470	560	670	670	1020

Model	Electrical power (W)	Usage temp. (°C / °C)	Protection index Classe	thermal cutout *	SEASON/FIRST & PREMIUM CO		INFINITE CO & SMART		PREMIUM BE		INFINITE BE	
					Power supply voltage (V / Ph / Hz)	Protection current (A)	Power supply voltage (V / Ph / Hz)	Protection current (A)	Power supply voltage (V / Ph / Hz)	Protection current (A)	Power supply voltage (V / Ph / Hz)	Protection current (A)
600	2x169W	-20/60	IP54/B	PTI	230 / 1 / 50	2,8	230 / 1 / 50	8,2	230 / 1 / 50	8,2	230 / 1 / 50	13,7
900	2x220W	-20/60	IP44/B	PTI	230 / 1 / 50	3,4	230 / 1 / 50	14,3	230 / 1 / 50	11,0	230 / 1 / 50	21,9
1300	2x400W	-20/40	IP44/F	PTI	230 / 1 / 50	8,6	230 / 1 / 50	23,8	230 / 1 / 50	19,5	230 / 1 / 50	34,7
1800	2x400W	-20/40	IP44/F	PTI	230 / 1 / 50	8,6	230 / 1 / 50	24,9	230 / 1 / 50	24,9	400 / 3+N / 50	15,1
2500	2x400W	-20/40	IP44/F	PTI	230 / 1 / 50	8,6	230 / 1 / 50	31,4	230 / 1 / 50	31,4	400 / 3+N / 50	19,5

*PTI: Integrated thermal cutout

MODULATION SOLUTIONS

NEOTIME®

The NEOTIME® station offers networked EASY regulation (except SEASON), enabling configuration of the flow modulations detailed below:

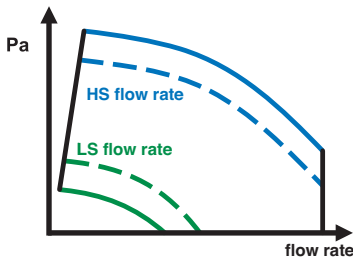

NEOTIME® ECO functioning

Choice of 1 or 2 flow rates (PV/ GV) per fan
Except SEASON, 1 adjustable flow rate per potentiometer

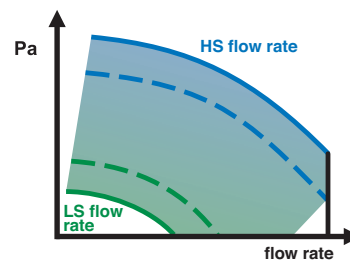

NEOTIME® DIVA functioning

PROPORTIONAL ventilation
between two flow rates (PV/ GV) per fan

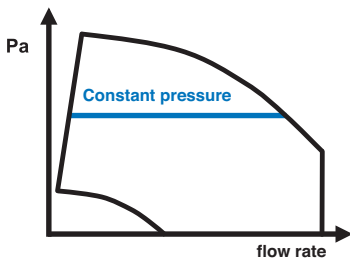

NEOTIME® LOBBY® functioning

CONSTANT PRESSURE ventilation per fan



Front access to internal NEOTIME® elements



Remote, LCD display control
(delivered as standard, except for the SEASON version)
max 100m or 1000m with repeater.



ED-TOUCH touch screen.
(optional, non-compatible with SEASON)
with user screen and maintenance interface (until 100m)

ECONOLOGICAL SOLUTIONS®



The Lp4m dB(A) curves correspond to the level of acoustic pressure at 4m in a hemispherical free field on a reflective plain, the "new air inlet" and "discharge intake air" sides not being connected, the "new output air" and "extraction intake air" not being connected. To achieve the overall acoustic pressure Lp dB(A), at a certain distance, add the values below to Lp4m.

Distance (m)	1,5	3	4	5	7	10
Distance weighting dB(A)	9	3	0	-2	-5	-8

The curves for "Lw output air cond dB(A)" correspond to the overall acoustic power emitted on the "new output air" side or "discharge intake air". To achieve the range of acoustic power Lw cond output dB(A), on the "new output air" or "discharge intake air", add the below values to the acoustic power "Lw cond output" displayed on the curves.

Downstream acoustic spectrum weighting function "Lw cond blower dB(A)" Indicated on the curves								
Frequency	63 Hz	125 Hz	250 Hz	500 Hz	1 kHz	2 kHz	4 kHz	8 kHz
Weighting NEOTIME 600 dB(A)	-37	-26	-15	-7	-5	-6	-9	-11
Weighting NEOTIME 900 dB(A)	-29	-17	-11	-7	-5	-5	-11	-18
Weighting NEOTIME 1300 dB(A)	-31	-20	-5	-8	-6	-8	-10	-16
Weighting NEOTIME 1800 dB(A)	-32	-20	-6	-8	-6	-8	-10	-13
Weighting NEOTIME 2500 dB(A)	-37	-23	-7	-8	-6	-7	-9	-13

The curves for "Lw cond extraction dB(A)" correspond to the overall acoustic power emitted on the duct sides "extraction air intake" and new air inlet". To achieve the range of acoustic power Lw cond extraction dB(A), on the "extraction air intake" and "new air inlet" sides, add the values below to the acoustic power "Lw cond extraction" read on the curves

Upstream acoustic spectrum weighting function "Lw cond extraction dB(A)" Indicated on the curves								
Frequency	63 Hz	125 Hz	250 Hz	500 Hz	1 kHz	2 kHz	4 kHz	8 kHz
Weighting NEOTIME 600 dB(A)	-32	-24	-14	-7	-5	-5	-11	-15
Weighting NEOTIME 900 dB(A)	-21	-12	-7	-5	-6	-10	-16	-22
Weighting NEOTIME 1300 dB(A)	-28	-19	-4	-8	-6	-8	-16	-23
Weighting NEOTIME 1800 dB(A)	-30	-19	-4	-8	-6	-8	-15	-20
Weighting NEOTIME 2500 dB(A)	-33	-21	-5	-8	-6	-7	-14	-20

To achieve the acoustic range NSC4 dB(A) (noise level at 4m in a hemispherical free field, with the device placed on the ground on a reflecting plane, with station terminals connected to the intake and discharge by ducts with the same level of sound insulation), deduct 18 dB(A) from the Lp4m value.

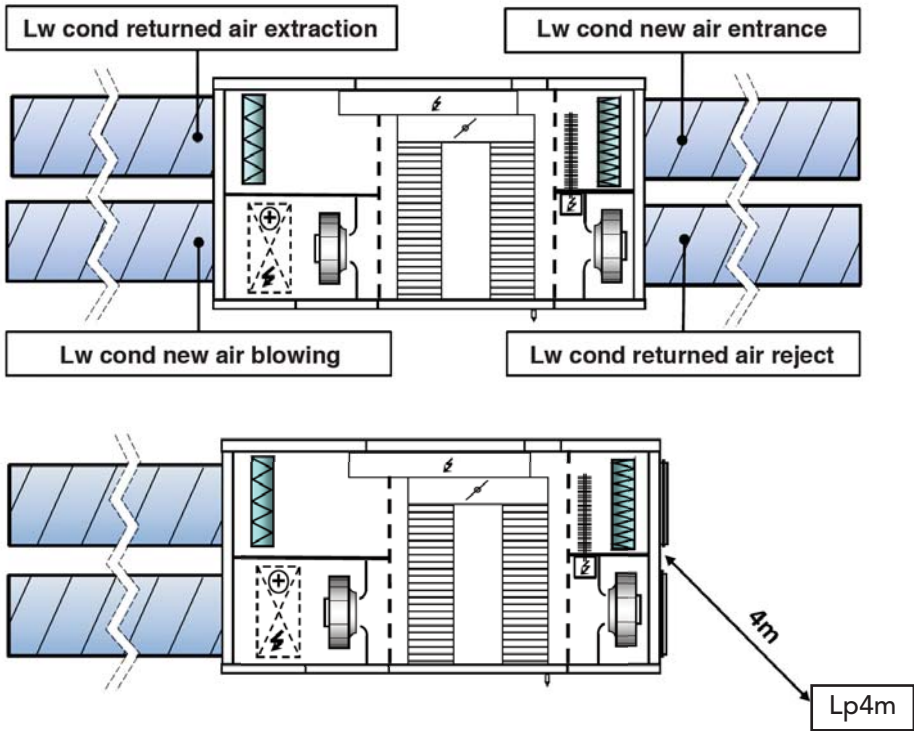

NOTA: Tolerance =
Global Values + / - 3 dB(A)
Acoustic spectra +/- 5 dB(A)



NOTA : the curves are created on the basis of new air (Static Pressure) all pressure gauges connected (configuration D in accordance with regulation NF EN 13141-4)



EQUIPMENT	SEASON	FIRST	SMART	PREMIUM BE	PREMIUM CO	INFINITE BE	INFINITE CO
Low energy consumption, EC fan motors	●	●	●	●	●	●	●
Opacimetric, F7 new air filter	●	●	●	●	●	●	●
Gravimetric, G4 intake filter	●	●	●	●	●	●	●
High efficiency plates (>90%), EUROVENT certified counter-flow exchanger	●	●	●	●	●	●	●
100% internal bypass	●	●	●	●	●	●	●
Inclined condensate trays (thermal CO battery and exchanger)	●	●	●	●	●	●	●
25 mm, RAL7035 double skin	●	●	●	●	●	●	●
Circular branch connections with lip seals (ATEC CSTB n° 13-224-12)	●	●	●	●	●	●	●
Remote, LCD display control (up to 100m)	-	●	●	●	●	●	●
Regulation MODBUS and BACNET RS485 network or TCP/IP WEB TCP/IP (selected from the menu)	-	●	●	●	●	●	●
Rotation speed regulating potentiometer	●	-	-	-	-	-	-
Discharge temperature sensor	-	●	●	●	●	●	●
Intake temperature sensor	-	●	●	●	●	●	●
Bypass defrost sensor	●	●	●	●	●	●	●
Exterior temperature sensor	●	●	●	●	●	●	●
Defrost battery sensor	-	-	●	-	-	●	●
Anti-freeze thermostat on the water battery	-	-	-	-	●	-	●
Electric safety thermostat defrost battery	-	-	●	-	-	●	●
Electric safety thermostat heating battery	-	-	-	●	-	●	-
Lockable proximity switch	●	●	●	●	●	●	●
Power cord grommet	●	●	●	●	●	●	●
FUNCTIONS	SEASON	FIRST	SMART	PREMIUM BE	PREMIUM CO	INFINITE BE	INFINITE CO
Bypass defrost	●	-	-	-	-	-	-
Sequenced defrost: bypass + battery (SMART/INFINITE) + new air flow rate modulation	-	●	●	●	●	●	●
Self-regulating, electric, defrost battery	-	-	●	-	-	●	●
Self-regulating, electric, heating battery	-	-	-	●	-	●	-
Self-regulating CHANGEOVER water battery (hot/cold)	-	-	-	-	●	-	●
100% internal bypass, All or Nothing, automatic management summer/winter	●	-	-	-	-	-	-
100% internal bypass, self-regulating and modulating (0-100%)	-	●	●	●	●	●	●
Free-Cooling Management	-	●	●	●	●	●	●
Night-cooling management (night-time over-ventilation)	-	●	●	●	●	●	●
Output air temperature management (air regulation)	-	●	●	●	●	●	●
Ambient temperature management (intake)	-	●	●	●	●	●	●
Weekly timer	◆	●	●	●	●	●	●
Holiday and public holiday timer	-	●	●	●	●	●	●
New Air filter pressure switch	●	●	●	●	●	●	●
Flow rate control pressure switch (output and intake)	●	●	●	●	●	●	●
Fire safety in accordance with 5 available modes	-	●	●	●	●	●	●
COMBIBOX CONCEPT® dehumidification management module	-	●	●	●	●	●	●
FACTORY INSTALLED OPTIONS	SEASON	FIRST	SMART	PREMIUM BE	PREMIUM CO	INFINITE BE	INFINITE CO
LOBBY®: air flow modulation at CONSTANT PRESSURE	-	○	○	○	○	○	○
DIVA®: proportional CO2 flow rate modulation	-	○	○	○	○	○	○
OPTIONS	SEASON	FIRST	SMART	PREMIUM BE	PREMIUM CO	INFINITE BE	INFINITE CO
Changeover pad for switching between hot/ cold for CO versions	-	◆	◆	◆	◆	◆	◆
Touch activated remote control (up to 100m)	-	◆	◆	◆	◆	◆	◆
LON networked	-	◆	◆	◆	◆	◆	◆
Ambient temperature management via touch activated remote control	-	◆	◆	◆	◆	◆	◆
1000M LCD repeater for remote control	-	◆	◆	◆	◆	◆	◆
Wonderoom®, networked area regulator Automatically with the NEOTIME®	-	◆	◆	◆	◆	◆	◆
COMBIBOX CONCEPT® dehumidification module	-	◆	◆	-	◆	-	◆

● : Standard equipment or functions.

○ : OPTIONAL equipment or functions. Supplied assembled and cabled at the factory

◆ : OPTIONAL equipment or functions. Supplied unassembled



NEOTIME® 600

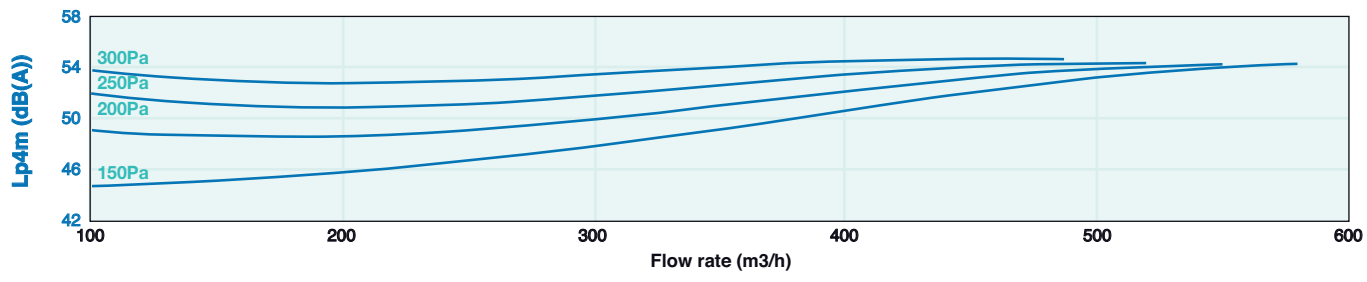
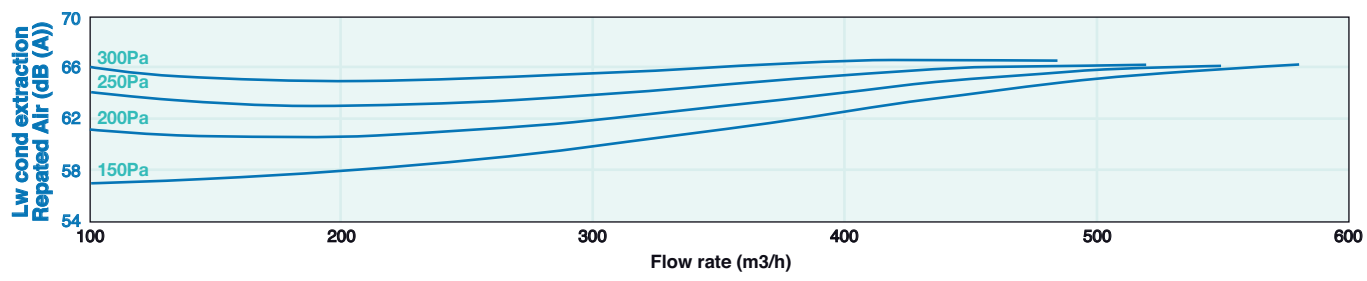
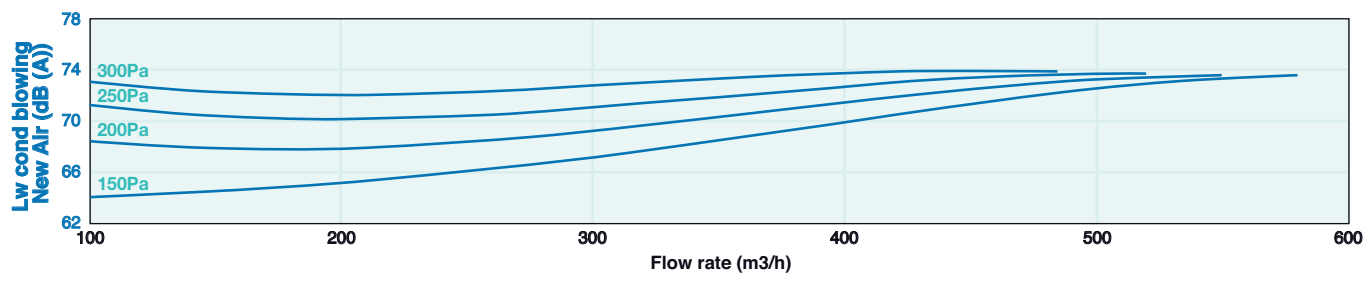
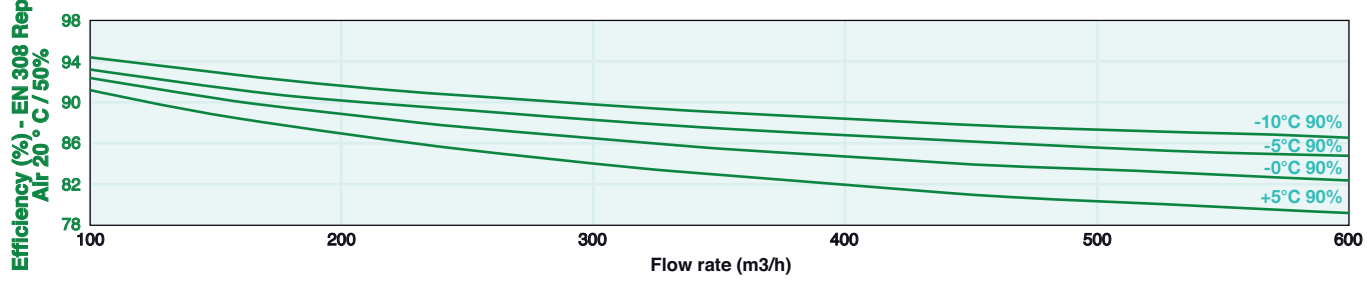
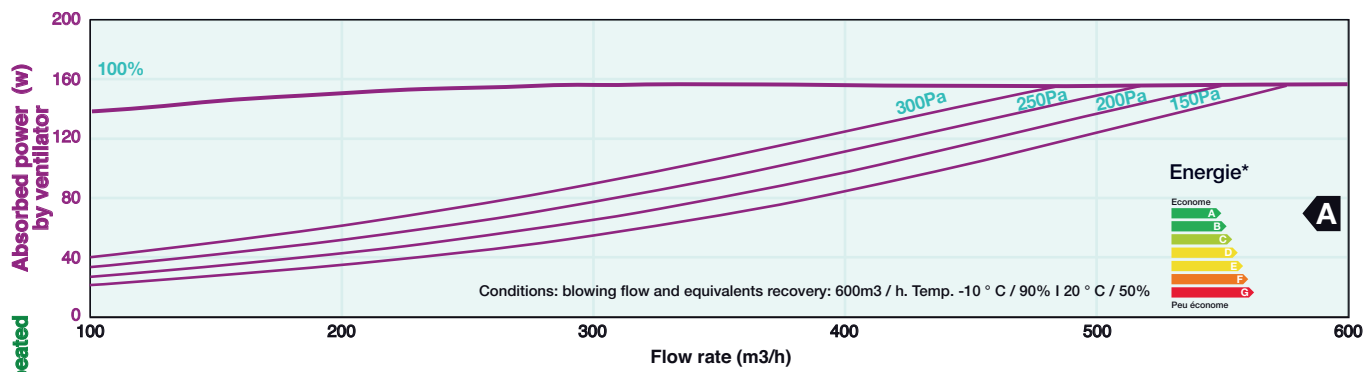
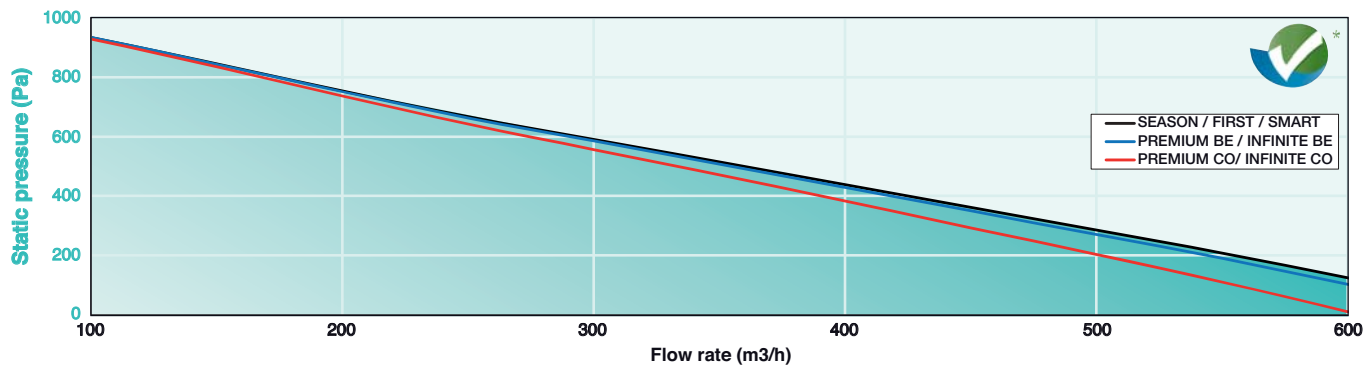



NEOTIME® 600

Changeover coil - PREMIUM / INFINITE CO

Water temp. (°C/°C)	Air inlet temp. (°C)	Flow rate (m³/h)	100	200	300	400	500	600	
80/60	11	Motor (kW)/Air outlet temp (°C)	1,8 / 65	3,2 / 58	4,3 / 54	5,3 / 50	6,2 / 48	6,9 / 46	
		Water flow(l/h)/DP water (kPa)	80 / 1	140 / 3	190 / 6	230 / 6	270 / 5	300 / 6	
	15	Motor (kW)/Air outlet temp (°C)	1,7 / 65	2,9 / 59	4,0 / 55	4,9 / 52	5,7 / 49	6,4 / 47	
		Water flow(l/h)/DP water (kPa)	70 / 1	130 / 3	170 / 5	210 / 5	250 / 4	280 / 5	
	60/50	11	Motor (kW)/Air outlet temp (°C)	1,3 / 51	2,4 / 46	3,2 / 43	4,0 / 41	4,6 / 39	5,3 / 37
			Water flow(l/h)/DP water (kPa)	120 / 3	210 / 5	280 / 5	350 / 8	410 / 11	460 / 13
15		Motor (kW)/Air outlet temp (°C)	1,2 / 51	2,1 / 47	2,9 / 44	3,6 / 42	4,2 / 40	4,8 / 39	
		Water flow(l/h)/DP water (kPa)	110 / 2	190 / 6	250 / 5	310 / 7	370 / 9	410 / 11	
45/40		11	Motor (kW)/Air outlet temp (°C)	1,0 / 39	1,7 / 36	2,3 / 34	2,9 / 32	3,4 / 31	3,8 / 30
			Water flow(l/h)/DP water (kPa)	170 / 5	290 / 6	400 / 11	500 / 14	580 / 18	660 / 23
	15	Motor (kW)/Air outlet temp (°C)	0,8 / 40	1,5 / 37	2,0 / 35	2,5 / 34	2,9 / 32	3,3 / 31	
		Water flow(l/h)/DP water (kPa)	140 / 4	260 / 5	350 / 8	430 / 12	500 / 14	570 / 18	
	7/12	32-40	Motor (kW)/Air outlet temp (°C-%HR)	0,9 / 13,2-91	1,6 / 15,4-86	2,1 / 16,8-82	2,5 / 17,8-80	2,9 / 18,5-78	3,3 / 19,2-76
			Water flow(l/h)/DP water (kPa)	160 / 5	270 / 6	360 / 10	430 / 15	500 / 16	560 / 20
27-50		Motor (kW)/Air outlet temp (°C-%HR)	0,7 / 12,7-94	1,2 / 14,5-89	1,6 / 15,6-87	1,9 / 16,4-85	2,2 / 17,0-83	2,4 / 17,4-82	
		Water flow(l/h)/DP water (kPa)	120 / 3	200 / 6	270 / 6	320 / 9	370 / 11	420 / 13	
25-50		Motor (kW)/Air outlet temp (°C-%HR)	0,5 / 12,6-94	0,9 / 14,1-90	1,2 / 15,0-87	1,3 / 15,6-90	1,5 / 16,2-86	1,7 / 16,8-83	
		Water flow(l/h)/DP water (kPa)	90 / 2	150 / 5	200 / 6	220 / 7	250 / 5	280 / 7	
6/11	32-40	Motor (kW)/Air outlet temp (°C-%HR)	1,0 / 12,3-91	1,7 / 14,6-85	2,3 / 16,1-82	2,7 / 17,2-79	3,2 / 18,0-77	3,6 / 18,7-76	
		Water flow(l/h)/DP water (kPa)	170 / 6	290 / 7	390 / 12	470 / 17	550 / 19	610 / 24	
	27-50	Motor (kW)/Air outlet temp (°C-%HR)	0,8 / 11,9-93	1,3 / 13,7-89	1,7 / 14,9-86	2,1 / 15,7-84	2,4 / 16,4-83	2,7 / 16,9-82	
		Water flow(l/h)/DP water (kPa)	130 / 4	220 / 7	300 / 7	360 / 10	420 / 14	460 / 17	
	25-50	Motor (kW)/Air outlet temp (°C-%HR)	0,6 / 11,7-94	1,0 / 13,3-90	1,3 / 14,3-87	1,6 / 15,1-85	1,6 / 15,6-89	1,8 / 16,2-86	
		Water flow(l/h)/DP water (kPa)	100 / 2	170 / 6	230 / 7	280 / 7	270 / 6	310 / 8	

NEOTIME® 600

Electric coil

Fresh air Flow rate (m³/h)	0° 600	-5° 600	-10° 600	-15° 600	-15°* 600	0° 600	-5° 600	-10° 600	-10°* 600	-10° 600	-15° 600	-15°* 600
Version	FIRST SEASON		SMART			PREMIUM BE			INFINITE BE			
			Preheating coil			Heating coil			Preheating + heating coil			
Total power kW	-		1,25			1,25			1,25 + 1,25			
Temp. °C on output from the unit	16,5	15,4	16,3	11,8	17,0	22,8	21,7	16,9	23,6	22,6	18	24,8

This data is provided to enable optimal regulation configuration relative to the exterior temperatures in question.
Permanent station output temperature, considering the proportional opening of the bypass to avoid exchanger frosting.
* 20% reduction of the NEW AIR flow rate (standard function).





NEOTIME® 900

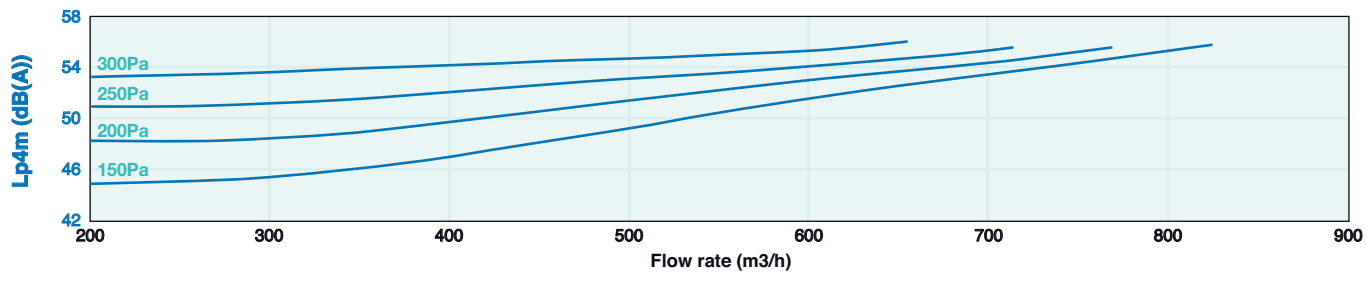
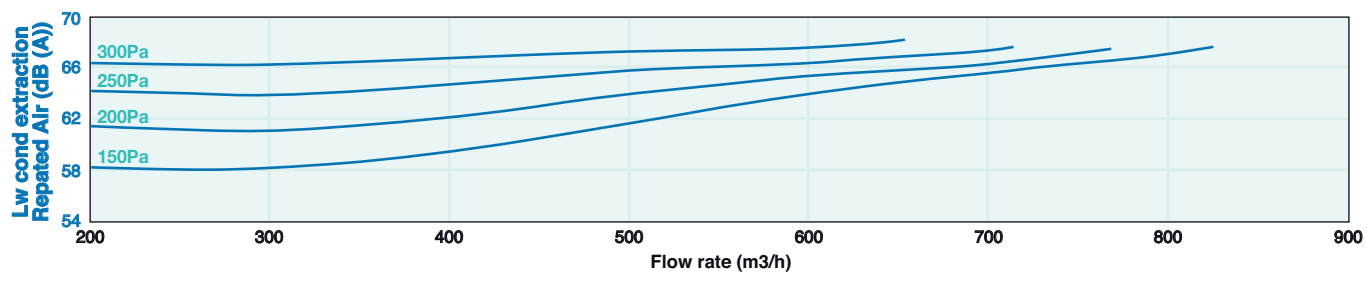
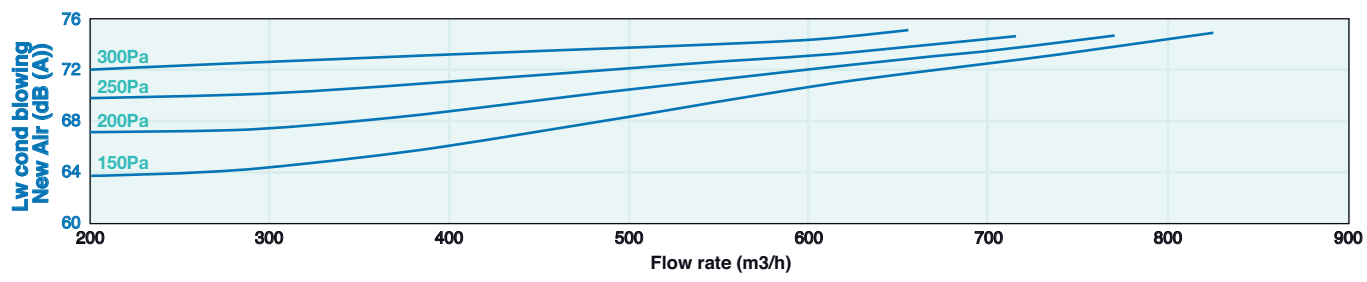
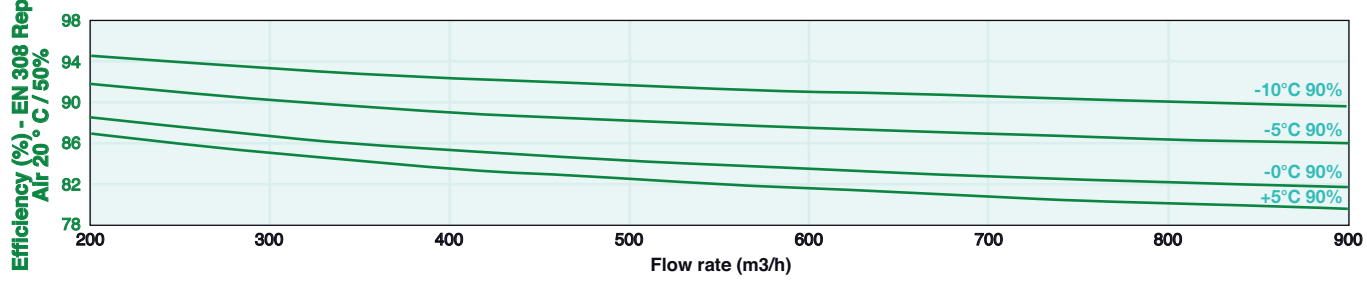
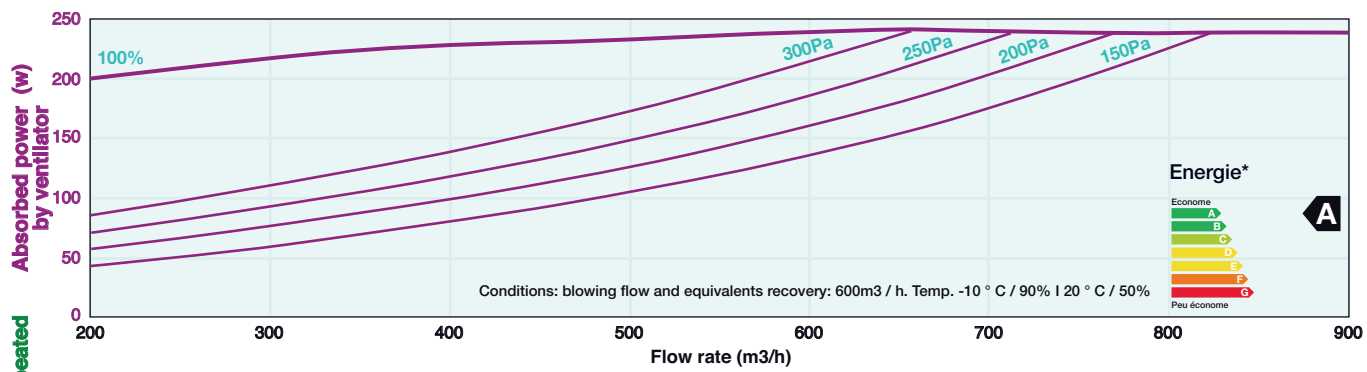
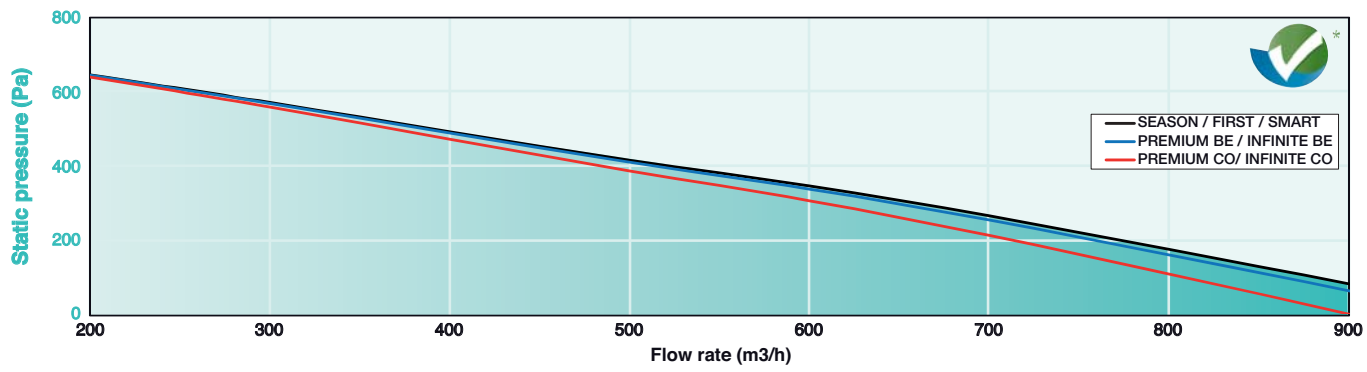



NEOTIME® 900

Changeover coil - PREMIUM / INFINITE CO

Water temp. (°C/°C)	Air inlet temp. (°C)	Flow rate (m³/h)	200	400	600	800	900
80/60	11	Motor (kW)/Air outlet temp (°C)	3,6 / 65	6,3 / 58	8,5 / 53	10,4 / 50	11,3 / 48
		Water flow(l/h)/DP water (kPa)	160 / 4	280 / 3	370 / 6	460 / 8	500 / 7
	15	Motor (kW)/Air outlet temp (°C)	3,4 / 65	5,8 / 59	7,9 / 54	9,7 / 51	10,5 / 50
		Water flow(l/h)/DP water (kPa)	150 / 3	260 / 3	350 / 5	420 / 7	460 / 8
60/50	11	Motor (kW)/Air outlet temp (°C)	2,7 / 51	4,7 / 46	6,4 / 43	7,8 / 40	8,5 / 39
		Water flow(l/h)/DP water (kPa)	230 / 5	410 / 7	550 / 9	680 / 14	740 / 16
	15	Motor (kW)/Air outlet temp (°C)	2,4 / 51	4,2 / 47	5,8 / 44	7,1 / 41	7,7 / 41
		Water flow(l/h)/DP water (kPa)	210 / 4	370 / 6	500 / 8	620 / 11	670 / 13
45/40	11	Motor (kW)/Air outlet temp (°C)	1,9 / 39	3,3 / 36	4,6 / 34	5,6 / 32	6,1 / 31
		Water flow(l/h)/DP water (kPa)	330 / 5	580 / 10	790 / 16	980 / 24	1060 / 28
	15	Motor (kW)/Air outlet temp (°C)	1,7 / 40	2,9 / 37	4,0 / 35	4,9 / 33	5,3 / 33
		Water flow(l/h)/DP water (kPa)	290 / 4	500 / 8	690 / 14	850 / 19	920 / 22
7/12	32-40	Motor (kW)/Air outlet temp (°C-%HR)	1,8 / 13,1-90	3,1 / 15,4-85	4,2 / 16,8-81	5,1 / 17,8-79	5,5 / 18,2-78
		Water flow(l/h)/DP water (kPa)	320 / 5	540 / 11	720 / 18	870 / 23	940 / 26
	27-50	Motor (kW)/Air outlet temp (°C-%HR)	1,4 / 12,6-93	2,4 / 14,4-89	3,2 / 15,6-86	3,8 / 16,3-84	4,1 / 16,7-83
		Water flow(l/h)/DP water (kPa)	240 / 7	410 / 8	540 / 11	660 / 15	710 / 17
25-50	Motor (kW)/Air outlet temp (°C-%HR)	1,1 / 12,5-93	1,8 / 14,0-89	2,4 / 15,0-86	2,5 / 15,6-90	2,7 / 15,9-88	
	Water flow(l/h)/DP water (kPa)	190 / 6	310 / 5	410 / 8	430 / 9	470 / 11	
6/11	32-40	Motor (kW)/Air outlet temp (°C-%HR)	2,0 / 12,3-90	3,4 / 14,7-84	4,5 / 16,2-81	5,5 / 17,2-78	6,0 / 17,7-77
		Water flow(l/h)/DP water (kPa)	340 / 6	580 / 12	780 / 19	950 / 27	1020 / 31
	27-50	Motor (kW)/Air outlet temp (°C-%HR)	1,6 / 11,8-93	2,6 / 13,7-88	3,5 / 14,9-86	4,3 / 15,7-84	4,6 / 16,1-83
		Water flow(l/h)/DP water (kPa)	270 / 4	450 / 10	600 / 13	730 / 19	790 / 19
25-50	Motor (kW)/Air outlet temp (°C-%HR)	1,2 / 11,6-93	2,1 / 13,3-89	2,7 / 14,3-86	3,3 / 15,0-84	3,6 / 15,4-83	
	Water flow(l/h)/DP water (kPa)	210 / 5	350 / 6	470 / 11	570 / 12	610 / 13	

NEOTIME® 900

Electric coil

Fresh air Flow rate (m³/h)	0° 900	-5° 900	-10° 900	-15° 900	-15°* 900	0° 900	-5° 900	-10° 900	-10°* 900	-10° 900	-15° 900	-15°* 900
Version	FIRST SEASON		SMART			PREMIUM BE			INFINITE BE			
			Preheating coil			Heating coil			Preheating + heating coil			
Total power kW	-		2,5			1,75			2,5 + 1,75			
Temp. °C on output from the unit	16,9	15,5	16,9	13,8	17,6	22,7	21,3	16,4	23,0	22,7	19,7	24,9

This data is provided to enable optimal regulation configuration relative to the exterior temperatures in question.
Permanent station output temperature, considering the proportional opening of the bypass to avoid exchanger frosting.
* 20% reduction of the NEW AIR flow rate (standard function).

AIR CONTROL SOLUTIONS®



NEOTIME® 1300

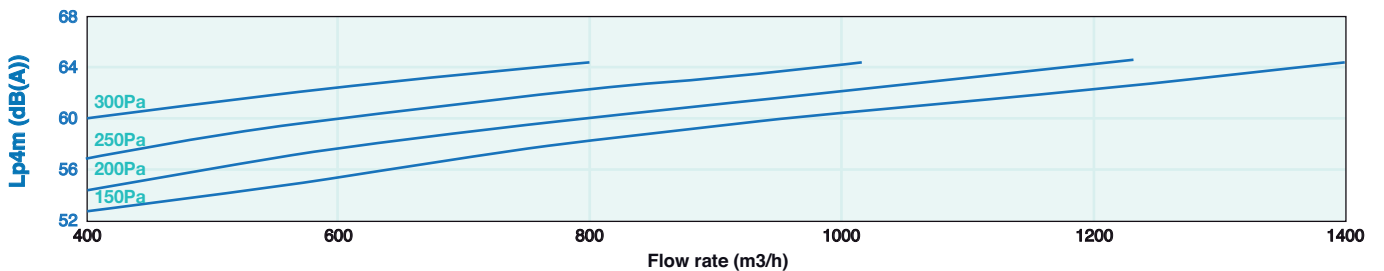
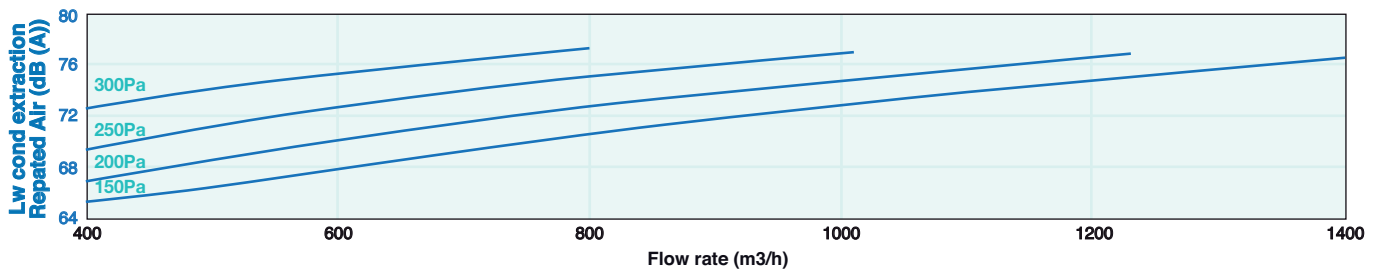
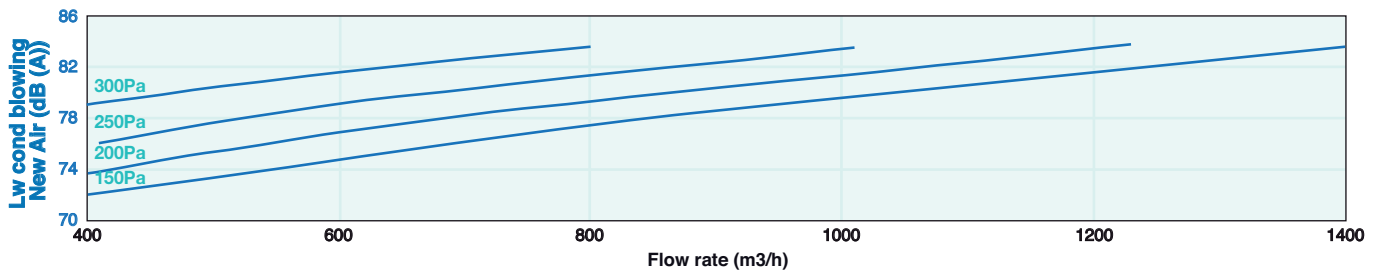
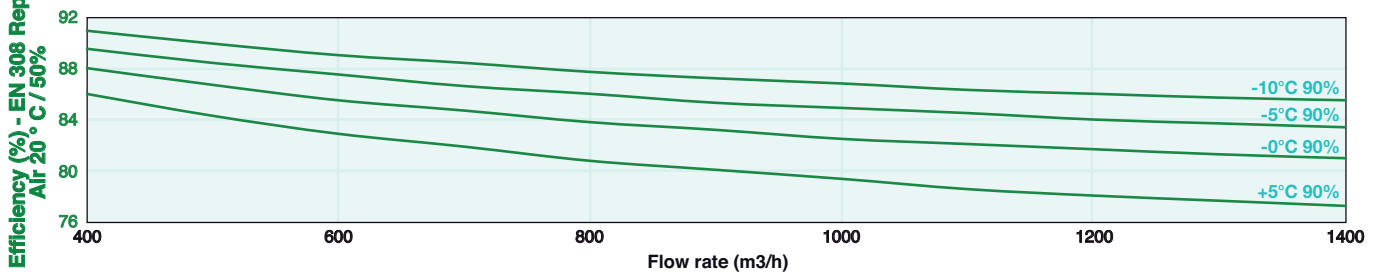
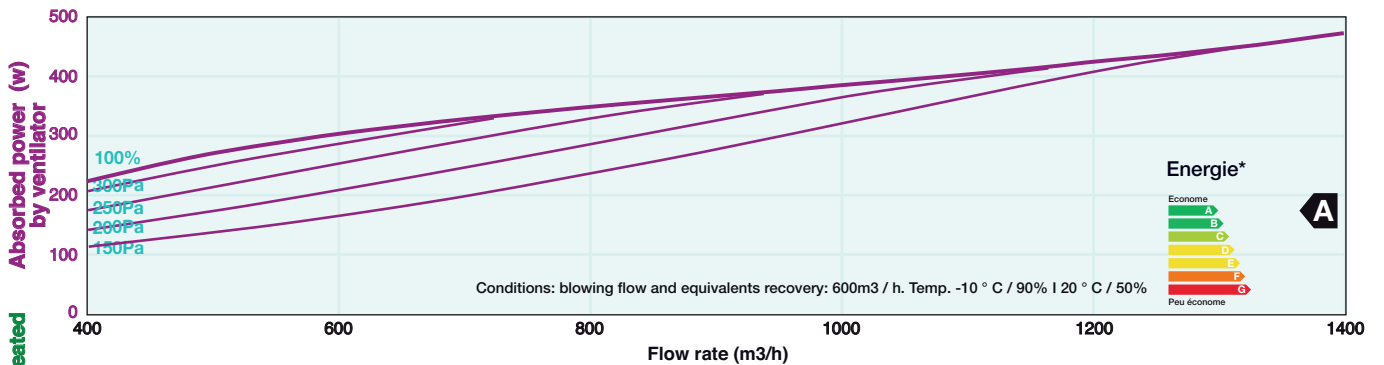
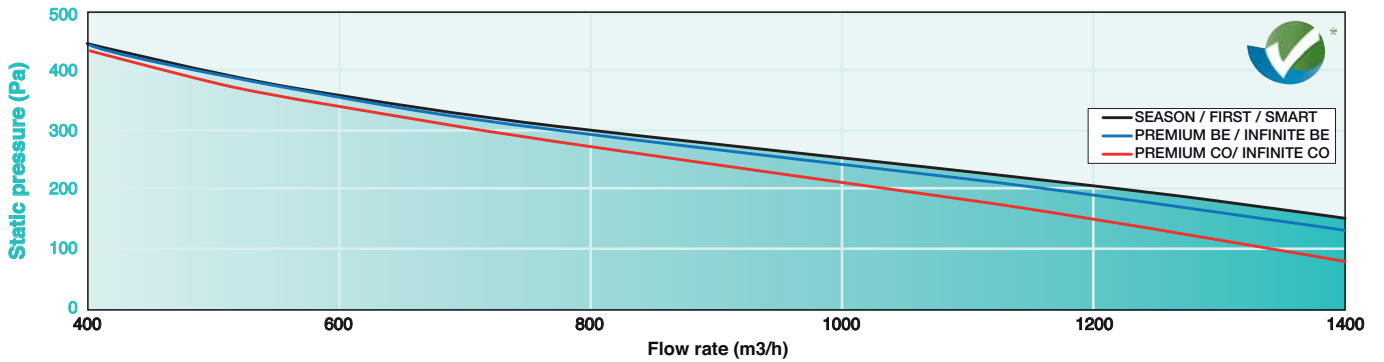

NEOTIME® 1300

Changeover coil - PREMIUM / INFINITE CO

Water temp. (°C/°C)	Air inlet temp. (°C)	Flow rate (m³/h)	400	600	800	1000	1200	
80/60	11	Motor (kW)/Air outlet temp (°C)	6,8/62	9,4/58	11,6/54	13,7/52	15,5/50	
		Water flow(l/h)/DP water (kPa)	300/4	410/8	510/9	600/12	680/15	
	15	Motor (kW)/Air outlet temp (°C)	6,4/63	8,7/58	10,8/55	12,7/53	14,4/51	
		Water flow(l/h)/DP water (kPa)	280/4	380/7	480/8	560/10	630/13	
	60/50	11	Motor (kW)/Air outlet temp (°C)	5,0/49	7,0/46	8,7/43	10,2/42	11,6/40
			Water flow(l/h)/DP water (kPa)	440/9	610/12	760/19	890/23	1010/28
15		Motor (kW)/Air outlet temp (°C)	4,6/49	6,3/47	7,9/44	9,3/43	10,5/41	
		Water flow(l/h)/DP water (kPa)	400/7	550/10	690/15	810/19	920/24	
45/40		11	Motor (kW)/Air outlet temp (°C)	3,6/38	5,0/36	6,2/34	7,3/33	8,3/32
			Water flow(l/h)/DP water (kPa)	620/14	860/22	1080/33	1270/43	1450/54
	15	Motor (kW)/Air outlet temp (°C)	3,1/38	4,3/37	5,4/35	6,4/34	7,3/33	
		Water flow(l/h)/DP water (kPa)	540/11	750/19	940/26	1110/35	1260/42	
	7/12	32-40	Motor (kW)/Air outlet temp (°C-%HR)	3,5/13,9-87	4,8/15,3-84	5,9/16,3-81	6,9/17,1-79	7,9/17,7-78
			Water flow(l/h)/DP water (kPa)	610/15	830/24	1020/35	1190/45	1350/56
27-50		Motor (kW)/Air outlet temp (°C-%HR)	2,7/13,1-91	3,7/14,2-88	4,6/15,1-86	5,3/15,7-84	6,0/16,2-83	
		Water flow(l/h)/DP water (kPa)	470/12	640/16	780/22	910/29	1030/36	
25-50		Motor (kW)/Air outlet temp (°C-%HR)	2,1/12,8-91	2,9/13,8-88	3,5/14,5-86	4,1/15,0-85	4,6/15,5-83	
		Water flow(l/h)/DP water (kPa)	370/8	490/10	600/15	700/19	780/22	
6/11	32-40	Motor (kW)/Air outlet temp (°C-%HR)	3,8/13,1-87	5,2/14,5-83	6,4/15,6-81	7,5/16,5-79	8,5/17,2-77	
		Water flow(l/h)/DP water (kPa)	650/17	890/28	1100/40	1280/51	1450/64	
	27-50	Motor (kW)/Air outlet temp (°C-%HR)	3,0/12,3-90	4,1/13,5-88	5,0/14,4-86	5,8/15,1-84	6,6/15,6-83	
		Water flow(l/h)/DP water (kPa)	510/11	700/20	860/26	1000/34	1130/41	
	25-50	Motor (kW)/Air outlet temp (°C-%HR)	2,4/12,0-91	3,2/13,1-88	4,0/13,8-86	4,6/14,4-84	5,2/14,9-83	
		Water flow(l/h)/DP water (kPa)	410/10	560/13	680/19	790/22	890/28	

NEOTIME® 1300

Electric coil

Fresh air Flow rate (m³/h)	0°	-5°	-10°	-15°	-15°*	0°	-5°	-10°	-10°*	-10°	-15°	-15°*
	1300	1300	1300	1300	1300	1300	1300	1300	1300	1300	1300	1300
Version	FIRST SEASON		SMART			PREMIUM BE			INFINITE BE			
			Preheating coil			Heating coil			Preheating + heating coil			
Total power kW	-		3,5			2,5			3,5+2,5			
Temp. °C on output from the unit	16,8	15,4	16,8	13,7	17,5	22,7	21,2	16,4	23,0	22,6	19,5	24,7

This data is provided to enable optimal regulation configuration relative to the exterior temperatures in question.
Permanent station output temperature, considering the proportional opening of the bypass to avoid exchanger frosting.
* 20% reduction of the NEW AIR flow rate (standard function).



NEOTIME® 1800

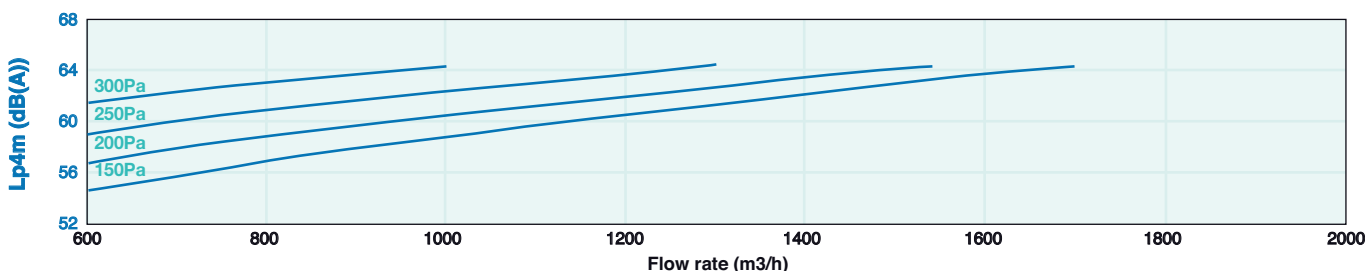
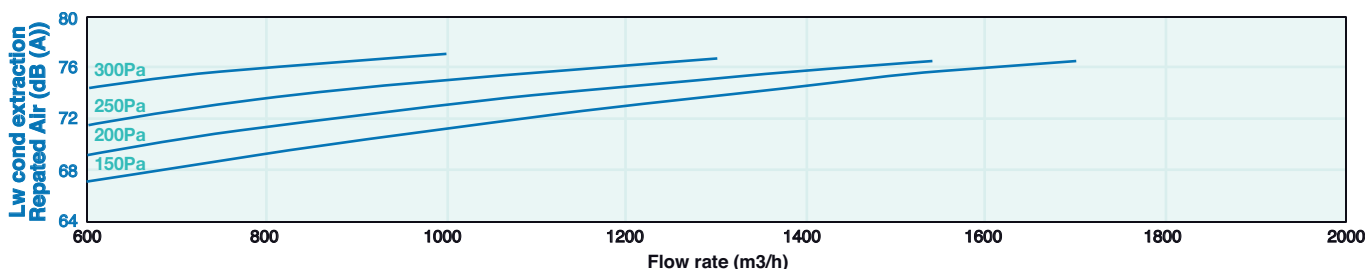
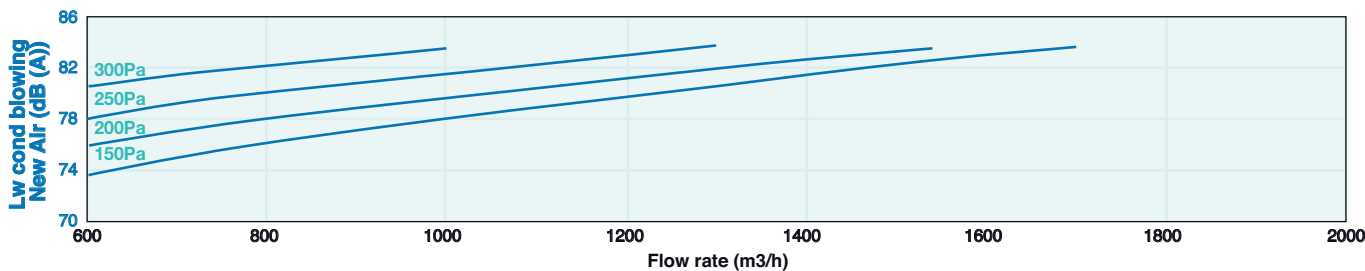
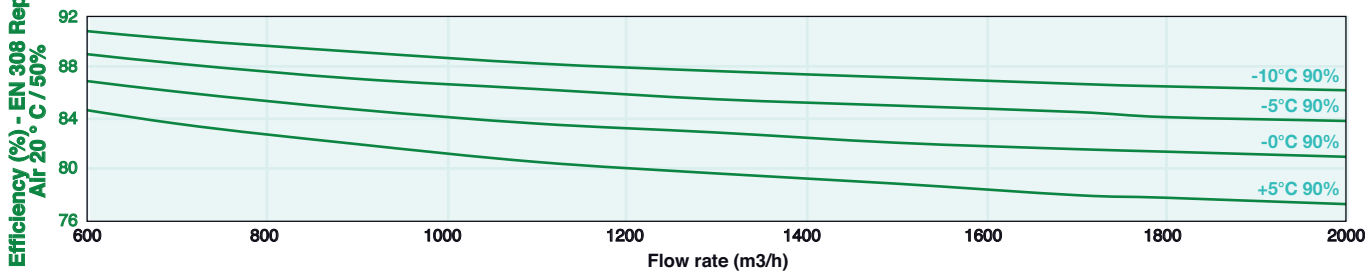
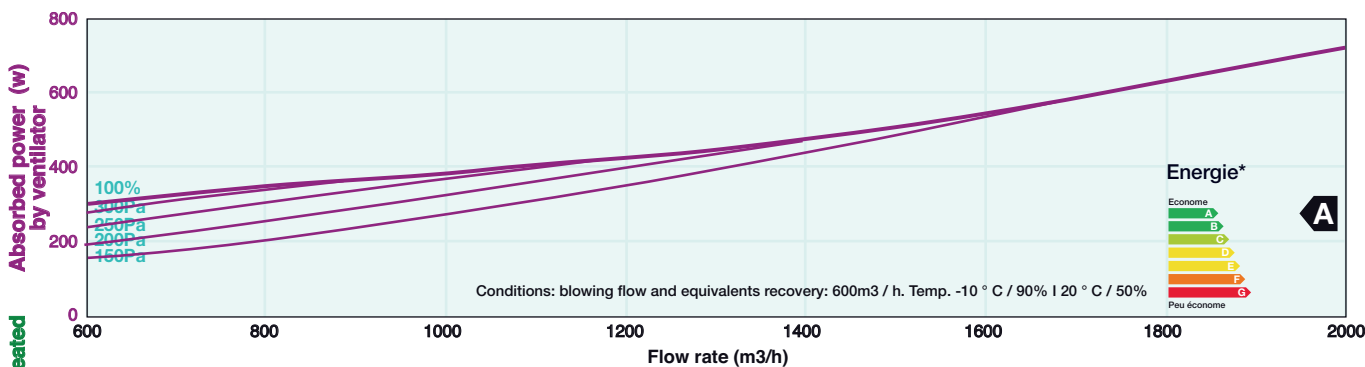
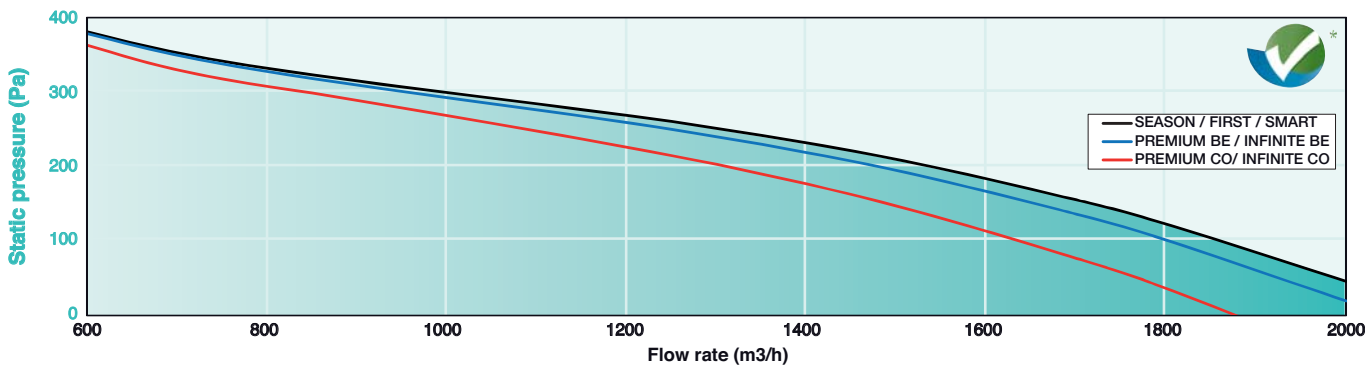



NEOTIME® 1800

Changeover coil - PREMIUM / INFINITE CO

Water temp. (°C/°C)	Air inlet temp. (°C)	Flow rate (m³/h)	800	1000	1200	1400	1600	1800	
80/60	11	Motor (kW)/Air outlet temp (°C)	11,5 / 54	13,5 / 51	15,4 / 49	17,1 / 47	18,7 / 46	20,2 / 44	
		Water flow(l/h)/DP water (kPa)	500 / 2	590 / 3	670 / 4	750 / 5	820 / 4	890 / 4	
	15	Motor (kW)/Air outlet temp (°C)	10,7 / 55	12,5 / 52	14,2 / 50	15,8 / 49	17,3 / 47	18,7 / 46	
		Water flow(l/h)/DP water (kPa)	470 / 4	550 / 3	630 / 3	700 / 4	760 / 5	820 / 4	
	60/50	11	Motor (kW)/Air outlet temp (°C)	8,6 / 43	10,2 / 41	11,6 / 40	12,9 / 39	14,2 / 37	15,3 / 36
			Water flow(l/h)/DP water (kPa)	750 / 5	890 / 4	1010 / 6	1130 / 5	1240 / 6	1340 / 7
15		Motor (kW)/Air outlet temp (°C)	7,8 / 44	9,2 / 43	10,5 / 41	11,7 / 40	12,8 / 39	13,8 / 38	
		Water flow(l/h)/DP water (kPa)	680 / 4	800 / 4	920 / 5	1020 / 6	1120 / 7	1210 / 6	
45/40		11	Motor (kW)/Air outlet temp (°C)	6,2 / 34	7,3 / 33	8,4 / 32	9,4 / 31	10,3 / 30	11,1 / 29
			Water flow(l/h)/DP water (kPa)	1080 / 6	1280 / 7	1460 / 9	1630 / 9	1780 / 11	1930 / 12
	15	Motor (kW)/Air outlet temp (°C)	5,4 / 35	6,4 / 34	7,3 / 33	8,1 / 32	8,9 / 32	9,6 / 31	
		Water flow(l/h)/DP water (kPa)	940 / 5	1110 / 7	1260 / 7	1410 / 8	1540 / 10	1670 / 9	
	7/12	32-40	Motor (kW)/Air outlet temp (°C-%HR)	5,4 / 16,8-83	6,3 / 17,6-81	7,1 / 18,2-80	7,9 / 18,7-78	8,6 / 19,2-77	7,3 / 19,9-82
			Water flow(l/h)/DP water (kPa)	930 / 6	1080 / 7	1220 / 7	1350 / 9	1470 / 10	1250 / 8
27-50		Motor (kW)/Air outlet temp (°C-%HR)	4,0 / 15,7-87	4,7 / 16,3-86	5,2 / 16,8-85	5,7 / 17,2-83	6,2 / 17,5-83	5,5 / 18,0-87	
		Water flow(l/h)/DP water (kPa)	690 / 5	800 / 4	890 / 5	980 / 6	1070 / 7	940 / 6	
25-50		Motor (kW)/Air outlet temp (°C-%HR)	2,7 / 14,8-94	3,2 / 15,5-90	3,6 / 16,0-87	4,0 / 16,4-85	4,4 / 16,8-83	4,7 / 17,2-81	
		Water flow(l/h)/DP water (kPa)	470 / 5	550 / 3	620 / 4	690 / 5	750 / 6	810 / 4	
6/11	32-40	Motor (kW)/Air outlet temp (°C-%HR)	5,9 / 16,2-83	6,9 / 17,0-81	7,8 / 17,6-79	8,6 / 18,2-78	9,4 / 18,7-77	10,1 / 19,1-76	
		Water flow(l/h)/DP water (kPa)	1010 / 6	1180 / 7	1330 / 9	1470 / 10	1600 / 10	1720 / 11	
	27-50	Motor (kW)/Air outlet temp (°C-%HR)	4,5 / 15,0-87	5,2 / 15,7-86	5,9 / 16,2-84	6,5 / 16,6-83	7,0 / 17,0-82	7,5 / 17,3-81	
		Water flow(l/h)/DP water (kPa)	770 / 4	890 / 5	1010 / 6	1110 / 8	1200 / 7	1290 / 8	
	25-50	Motor (kW)/Air outlet temp (°C-%HR)	3,4 / 14,5-88	4,0 / 15,0-86	3,9 / 15,3-91	4,3 / 15,8-88	4,7 / 16,2-86	5,1 / 16,6-84	
		Water flow(l/h)/DP water (kPa)	590 / 4	680 / 5	670 / 5	740 / 5	810 / 4	870 / 5	

NEOTIME® 1800

Electric coil

Fresh air Flow rate (m³/h)	0°	-5°	-10°	-15°	-15°*	0°	-5°	-10°	-10°*	-10°	-15°	-15°*
	1800	1800	1800	1800	1800	1800	1800	1800	1800	1800	1800	1800
Version	FIRST SEASON		SMART			PREMIUM BE			INFINITE BE			
			Preheating coil			Heating coil			Preheating + heating coil			
Total power kW	-		3,75			3,75			3,75+3,75			
Temp. °C on output from the unit	16,3	15,6	16,1	11,7	16,7	22,6	21,8	16,8	23,5	22,4	18,0	24,5

This data is provided to enable optimal regulation configuration relative to the exterior temperatures in question.
Permanent station output temperature, considering the proportional opening of the bypass to avoid exchanger frosting.
* 20% reduction of the NEW AIR flow rate (standard function).

NEOTIME® 2500

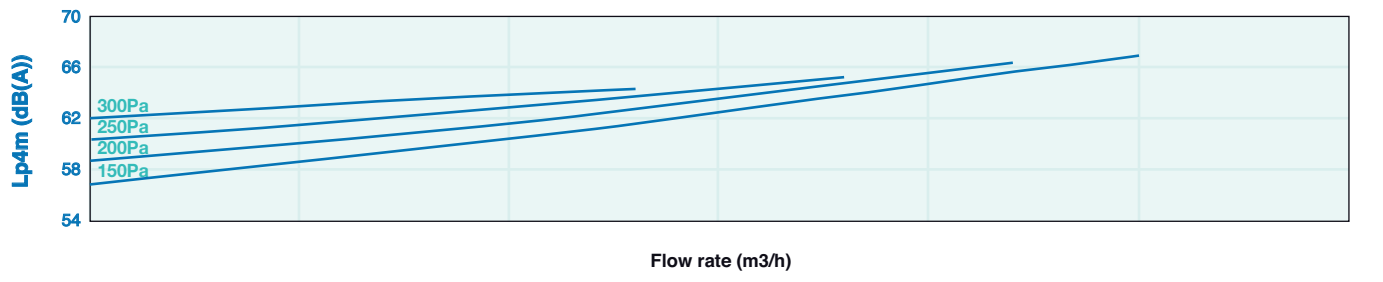
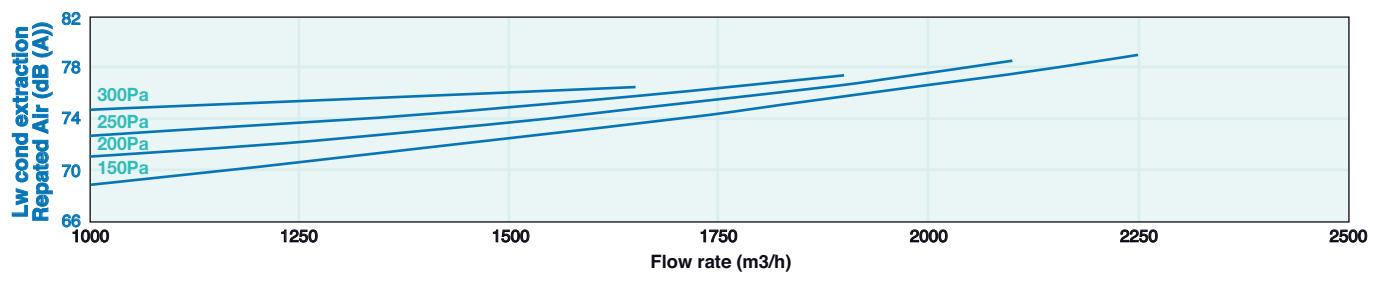
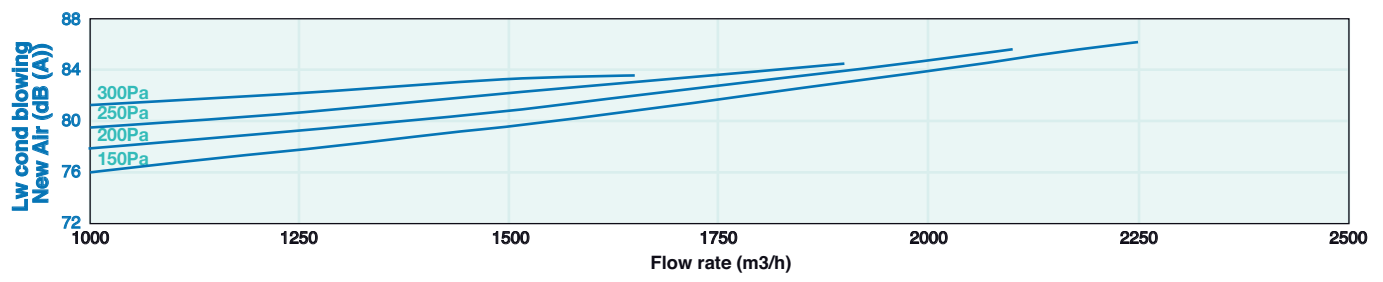
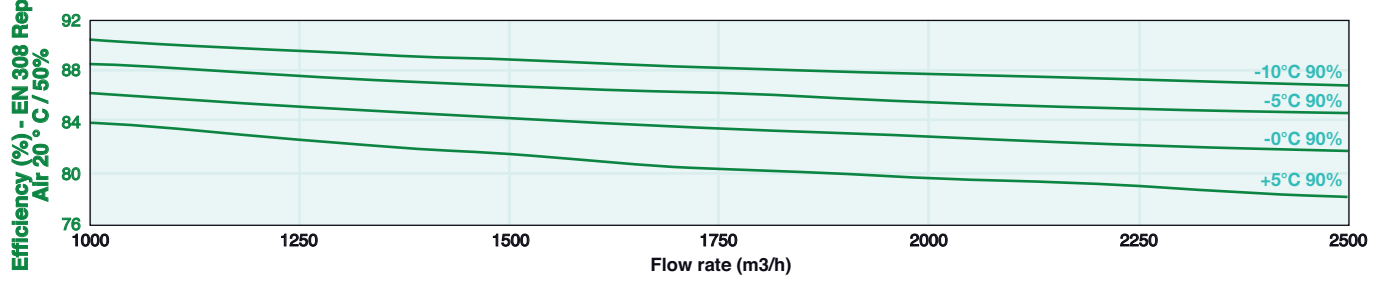
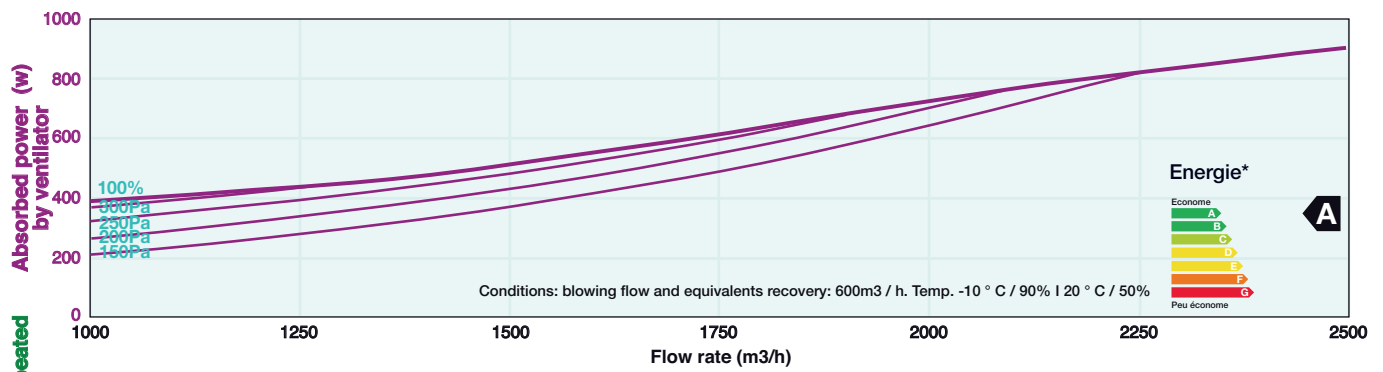
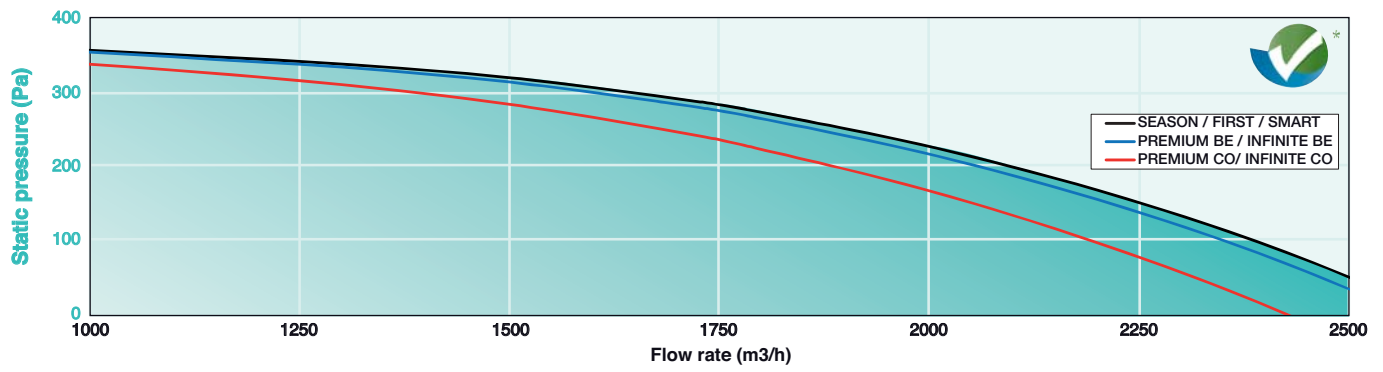

NEOTIME® 2500

Changeover coil - PREMIUM / INFINITE CO

Water temp. (°C/°C)	Air inlet temp. (°C)	Flow rate (m³/h)	1250	1500	1750	2000	2250	2500	
80/60	11	Motor (kW)/Air outlet temp (°C)	19,0 / 56	21,8 / 54	24,4 / 53	26,8 / 51	29,1 / 50	31,2 / 48	
		Water flow(l/h)/DP water (kPa)	830 / 5	960 / 6	1070 / 7	1180 / 7	1280 / 8	1370 / 9	
	15	Motor (kW)/Air outlet temp (°C)	17,7 / 57	20,2 / 55	22,7 / 54	24,9 / 52	27,0 / 51	29,0 / 50	
		Water flow(l/h)/DP water (kPa)	780 / 4	890 / 5	1000 / 6	1090 / 7	1190 / 7	1280 / 8	
	60/50	11	Motor (kW)/Air outlet temp (°C)	14,2 / 45	16,3 / 43	18,2 / 42	20,1 / 41	21,8 / 40	23,5 / 39
			Water flow(l/h)/DP water (kPa)	1240 / 8	1420 / 10	1590 / 11	1750 / 13	1900 / 15	2050 / 17
15		Motor (kW)/Air outlet temp (°C)	12,9 / 46	14,7 / 44	16,5 / 43	18,2 / 42	19,8 / 41	21,2 / 40	
		Water flow(l/h)/DP water (kPa)	1120 / 8	1290 / 8	1440 / 10	1590 / 10	1730 / 12	1860 / 14	
45/40		11	Motor (kW)/Air outlet temp (°C)	10,1 / 35	11,6 / 34	13,1 / 33	14,4 / 33	15,7 / 32	16,9 / 31
			Water flow(l/h)/DP water (kPa)	1760 / 13	2020 / 17	2270 / 21	2500 / 25	2720 / 27	2930 / 31
	15	Motor (kW)/Air outlet temp (°C)	8,8 / 36	10,1 / 35	11,4 / 34	12,5 / 34	13,6 / 33	14,7 / 33	
		Water flow(l/h)/DP water (kPa)	1530 / 12	1760 / 13	1980 / 16	2180 / 19	2370 / 23	2550 / 26	
	7/12	32-40	Motor (kW)/Air outlet temp (°C-%HR)	9,6/15,7-83	10,9/16,4-82	12,2/16,9-80	13,4/17,4-79	14,5/17,8-78	15,5/18,2-77
			Water flow(l/h)/DP water (kPa)	1650 / 14	1880 / 17	2090 / 21	2290 / 25	2480 / 28	2660 / 31
27-50		Motor (kW)/Air outlet temp (°C-%HR)	7,3/14,7-88	8,3/15,2-86	9,2/15,6-85	10,1/16,0-84	10,9/16,3-83	11,7/16,6-83	
		Water flow(l/h)/DP water (kPa)	1260 / 10	1430 / 12	1580 / 13	1730 / 15	1870 / 17	2000 / 19	
25-50		Motor (kW)/Air outlet temp (°C-%HR)	5,6/14,2-88	6,4/14,6-87	7,0/15,0-86	7,7/15,3-85	7,1/15,6-90	7,7/15,9-88	
		Water flow(l/h)/DP water (kPa)	960 / 7	1090 / 9	1210 / 9	1320 / 10	1220 / 9	1310 / 10	
6/11	32-40	Motor (kW)/Air outlet temp (°C-%HR)	10,3/15,1-83	11,8/15,7-81	13,2/16,3-80	14,4/16,8-79	15,6/17,3-78	16,8/17,7-77	
		Water flow(l/h)/DP water (kPa)	1770 / 16	2020 / 20	2260 / 24	2470 / 29	2680 / 31	2870 / 36	
	27-50	Motor (kW)/Air outlet temp (°C-%HR)	8,1/14,0-87	9,2/14,5-86	10,2/15,0-85	11,2/15,4-84	12,1/15,7-83	13,0/16,0-82	
		Water flow(l/h)/DP water (kPa)	1380 / 12	1580 / 13	1750 / 15	1920 / 18	2080 / 21	2220 / 24	
	25-50	Motor (kW)/Air outlet temp (°C-%HR)	6,4/13,5-88	7,2/14,0-86	8,0/14,4-85	8,8/14,7-84	9,5/15,0-84	10,1/15,3-83	
		Water flow(l/h)/DP water (kPa)	1090 / 9	1240 / 10	1380 / 11	1500 / 13	1620 / 13	1730 / 15	

NEOTIME® 2500

Electric coil

Fresh air Flow rate (m³/h)	0°	-5°	-10°	-15°	-15°*	0°	-5°	-10°	-10°*	-10°	-15°	-15°*
	2500	2500	2500	2500	2500	2500	2500	2500	2500	2500	2500	2500
Version	FIRST SEASON		SMART			PREMIUM BE			INFINITE BE			
			Preheating coil			Heating coil			Preheating + heating coil			
Total power kW	-		5,25			5,25			5,25+5,25			
Temp. °C on output from the unit	16,4	15,5	16,2	11,9	16,8	22,7	21,8	17,0	23,7	22,5	18,2	24,7

This data is provided to enable optimal regulation configuration relative to the exterior temperatures in question.
Permanent station output temperature, considering the proportional opening of the bypass to avoid exchanger frosting.
* 20% reduction of the NEW AIR flow rate (standard function).





• SECURITY AND CONTROL

**PRESSOSTAT
FOULING ref. DEP**

Return air Filter (IP54)

**MANOMETER
WITH LIQUID J
ref. MANO****SMOKS ALARM
ref. CDAD**

Cabinet (IP54)

• MODULATION FLOW

**DEPORTED
COMMAND
ref. POT VF**Potentiometer only for
SEASON (IP54)**COMMANDED
OUTSTRIP
COMFORT
ref. CDC2V2**STOP /PV/GV 2 Ventilators
CASE (IP54)**COMMANDED
OUTSTRIP
COMFORT
ref. CDC PVGV2**PV/GV 2 Ventilators CASE
(IP54)**PRESENCE
DETECTOR
ref. 360 TOR SA**ON/OFF or
PV/GV(SEASON
incompatible version)**BOX RELEASE
ref. BD**TBTS 24 or 48Vcc
CASE (IP67)**COMMANDED
OUTSTRIP
COMFORT
ref. CDC1V2**On/off/PV/GV 2 Ventilators
CASE (IP54)

• CLIMATIC

**THERMOSTAT REVERSER
SUMMER/WINTER ref.
CHANGEOVER PAD**

For PREMIUM/INFINITE CO versions

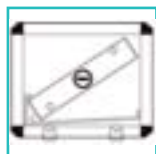
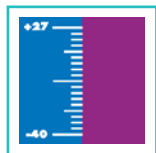
**DIRECT EXPANSION MODULE
R410A ref. CBX DX**Installation in ducts (to see chapter
AIR TREATMENT for descriptions).
SEASON incompatible version**DEHUMIDIFYING MODULE
ref. CBX --**Installation in girdle (to see chapter
AIR TREATMENT for descriptions).
SEASON incompatible version**CIRCULAR REGISTER
ref. RC4A**

Frost protection. Waterproof class 4

• INSTALLATION

**FLEXIBLE SLEEVE
ref. MTS M0**Fire classification: M0
Male diameters (supply) / Female
(Central side)**SUPPORT FEET
ref. PCB**Set of 4 (100 mm).
For floor mounting**DUCT HUMIDITY SENSOR
ref. HR 010 SG**

Signal 0-10V (SEASON incompatible version)

**DUCT HUMIDITY SENSOR
ref. HR 010 SA**

Signal 0-10V (SEASON incompatible version)

**SOLENOID VALVE KIT ref. KEI IP44**PREMIUM/INFINITE CO Versions. Type 15/1.6-3/8" M
for NEOTIME® 600 600/900/1300. Type 15/2.5-1/2" M
for NEOTIME® 900/1300. Type 20/6.3 - 3/4" F for
NEOTIME® 1800/2500

• RÉGULATION

**WALL CONTROL TOUCH
ref. EDTOUCH**

SEASON incompatible version

**REPEATER ref. REPEATER 1M**

SEASON incompatible version

To deport the standard wall command supplied with
the power plant (tactile command not compatible
ED-TOUCH) or to pilot with a command until 6
NEOTIME®**MULTIFUNCTION ZONE REGULATOR
ref. WONDEROOM**To associate with the versions modulation of flow miss
LOBBY® (Constant pressure). Besides the management of
the zone. Regulator communicates with the power plant
NEOTIME®



AIR PROCESSING | AIR CONDITIONING | REGULA-

AIR CONTROL SOLUTION[®]

To meet the requirements of design departments, building inspectors' offices, architects and often installation problems, we carry out Research and Development to conceive, design and manufacture equipment and systems which combine the diversity of the requirements with technical compliance with performance and expected results.

ECONOLOGICAL SOLUTIONS[®]

Actively present for more than 30 years in the climatic engineering domain, we are working to provide solutions and answers through technical characteristics dedicated to progress.

Through a continuous technological and regulatory watch, we envisage, propose and define eco-friendly equipment and systems.

This double approach, both economical and ecological, represents our wish to contribute to the respect for future generations.

THE FUTURE EVERY DAY[®]

This vision drives us forward and is demonstrated by the commitment ("PFCT" on page 8) which characterises our quality process.

Intentionally facing the future, our enthusiasm is your confidence which supports us every day through a concrete and durable partnership.

Enriched by our past experiences, we work every day with this dynamic vision which drives our developments and our partnerships.