



**BSK NOTUS HV**  
**NEW GENERATION HEAT RECOVERY DEVICE**

[www.bskhvac.com.tr](http://www.bskhvac.com.tr)



# Contents



General Information

2

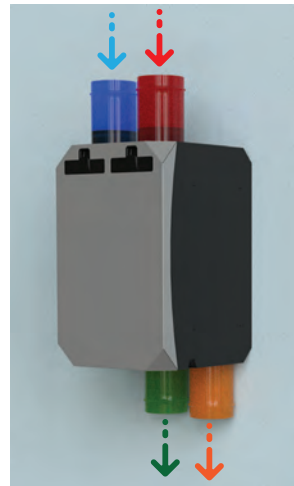

Airway Orientation

5



Accessories

8

Technical Data and Dimensions

4



Control Options

6



## New Generation Residential Heat Recovery Device

Heat Recovery Ventilation devices play a vital role in creating healthy, energy-efficient indoor environments. Their ability to recover heat while maintaining indoor air quality makes them a valuable addition to modern building systems.

**BSK NOTUS** Heat Recovery Ventilation devices are advanced mechanical ventilation systems designed to efficiently exchange indoor and outdoor air while minimizing energy loss. These units are employed in residential areas to maintain indoor air quality, reduce energy consumption, and enhance overall comfort.

**BSK NOTUS** HRV devices work by extracting stale indoor air from various areas of a building, such as bathrooms, kitchens, and living spaces. Simultaneously, fresh outdoor air is introduced into the building. The core feature of **BSK NOTUS** HRV systems is their heat recovery mechanism. These systems use a heat exchanger to transfer heat from the outgoing air stream to the incoming fresh air stream. This transfer of heat helps to pre-condition the incoming air, reducing the energy required to heat or cool it to the desired indoor temperature.



### Plug-and-play connections

The electrical connections for our devices are conveniently located on the exterior case, accessible via dedicated sockets. This Plug-and-Play design eliminates the need for professional intervention, allowing straightforward, hassle-free setup. Simply connect the appropriate accessory cable to its corresponding socket for seamless operation, right from the moment you unbox the product.



### Humidity control

Thanks to the built-in humidity sensor, our devices effectively monitor the humidity levels of the return air. When the user-set humidity threshold is reached, the device will automatically enter humidity boost mode and adjust the fan speeds, promptly removing excess moisture from the environment. Once the humidity level stabilizes, the device seamlessly resumes its normal operation.



### Mainboard and Extension Modules

Our mainboard is capable of all the standard ventilation requirements like automatic bypass damper control or weekly scheduling and some more like Wi-Fi connectivity. But your ventilation needs may necessitate some extra functionality or the building regulations may change to incorporate a new standard. We are designing ahead of the future and enabled our devices to be upgraded with various extension modules. If your project needs a specific application, we may be able to offer that function via an extension module.



## Components

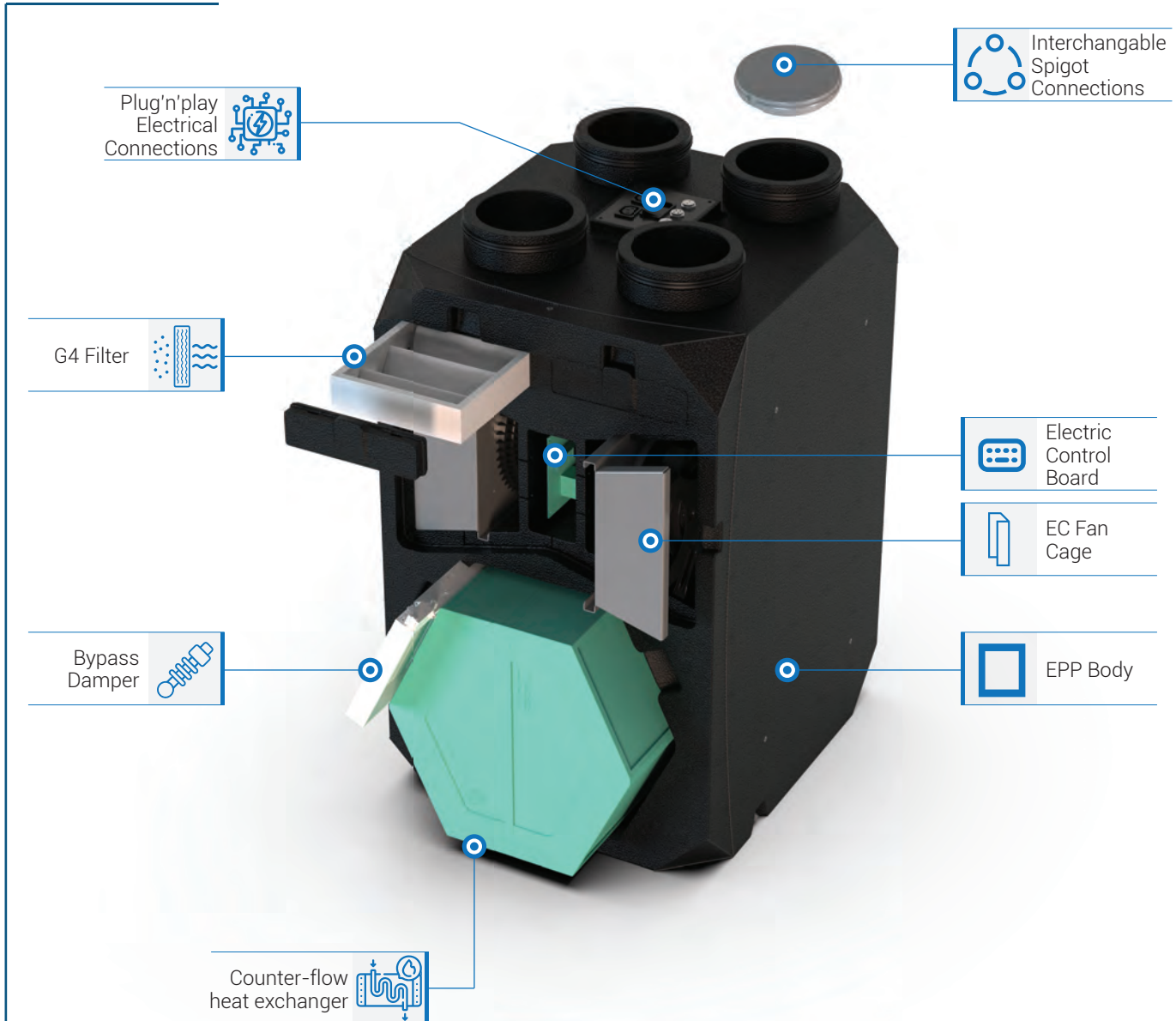

**Body**

Expanded Polypropylene (EPP) is a versatile and lightweight plastic foam material derived from polypropylene through a molding and expansion process. EPP is valued for its versatility and performance in a wide range of industries and applications where its lightweight, impact-absorbing, and insulating properties make it a perfect body material for HRV units.

**Heat Exchanger**

The heart of the BSK NOTUS HRV system is the high efficiency counter-flow heat exchanger. This component facilitates the transfer of heat between the outgoing and incoming air streams without direct mixing.

**Filters**

BSK NOTUS HRV have 2 filters on both supply and exhaust air streams. These filters clean the incoming air by removing dust, allergens, and other pollutants. This ensures that the indoor air remains fresh and healthy while keeping the inside of the device clean and protected.

**EC Fans**

Low energy fans with backward curved blades and EC motors are responsible for moving the air through the system. They extract stale air from the building and introduce fresh air from outside.

**Controls**

BSK NOTUS HRV system comes with advanced controls that allow users to adjust settings based on their preferences. These controls include fan speed controls, filter alarms and sensor readings and smart features such as automatic boost modes and weekly scheduling.

## Technical Data and Dimensions

BSK NOTUS	
Energy class	A+
Max. air flow (@100 Pa)	350 m <sup>3</sup> /h
Max. thermal efficiency	90 %
Supply voltage	230V AC 50Hz
Max. Electric Power	160 W, 0.7 A
Casing material	Expanded Polypropylene (EPP)
Dimensions (LxWxH)	550x500x850 mm
Weight	20 kg
Heat Exchanger type	Plastic counter flow (optional enthalpy)
Fan & Motor type	Backward-curve fans with EC motors
Filter class	2 x G4 filter (optional F7)
Duct Connections	both Ø 160 mm and Ø 125 mm
Condensation drain	Ø 20 mm
Mounting Options	Horizontal (both Left and Right) - Vertical (both Top and Bottom)
Operating temperatures	-25°C to +60°C

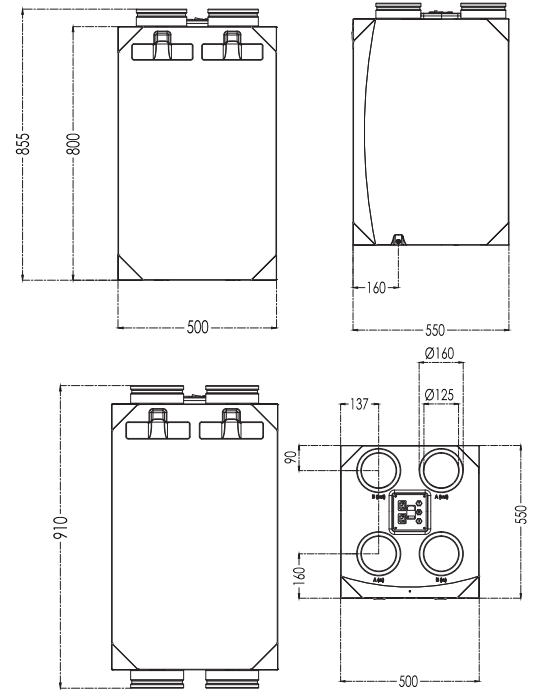

## Performance Graphs

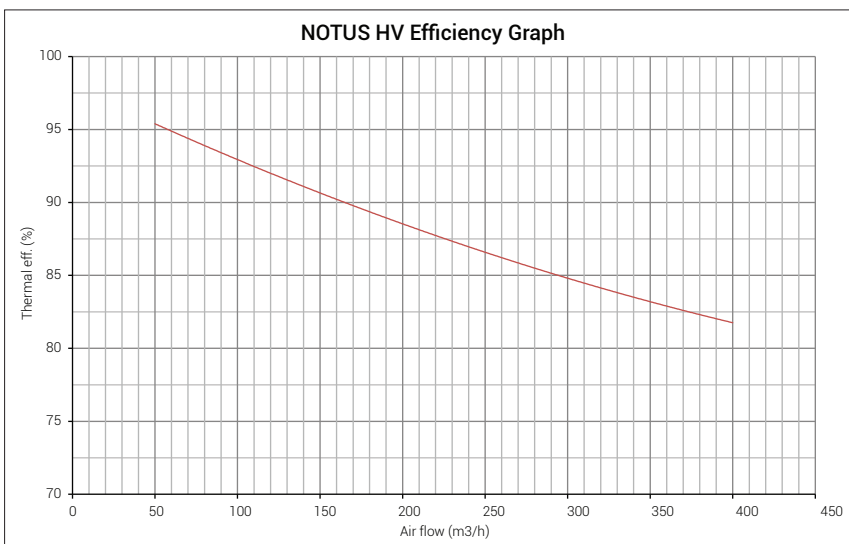
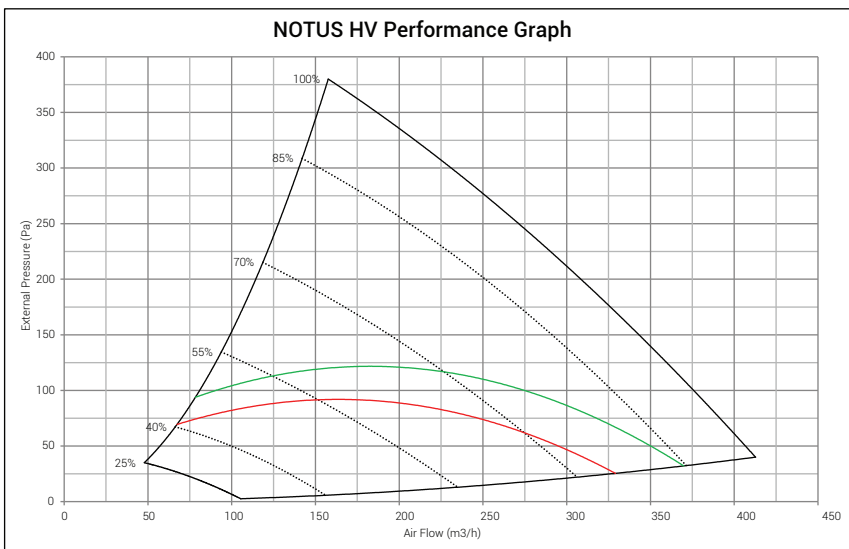

## 8 Different Airway Orientation

**Vertical Top In / Top Out Left**  
V-TITO-L

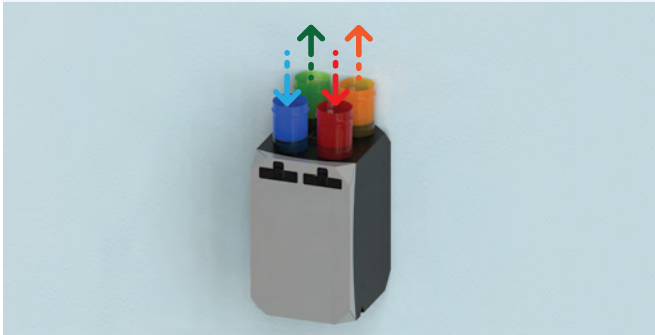

**Vertical Top In / Top Out Right**  
V-TITO-R (factory set)

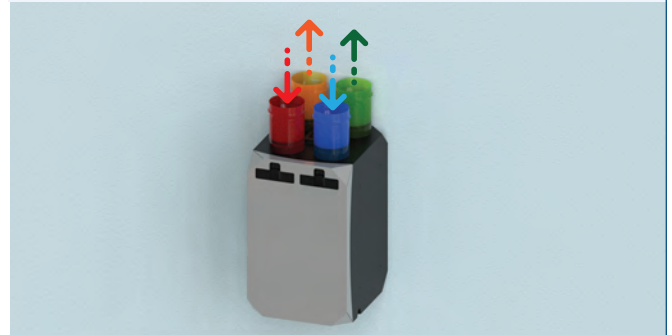

**Vertical Top In / Bottom Out Left**  
V-TIBO-L

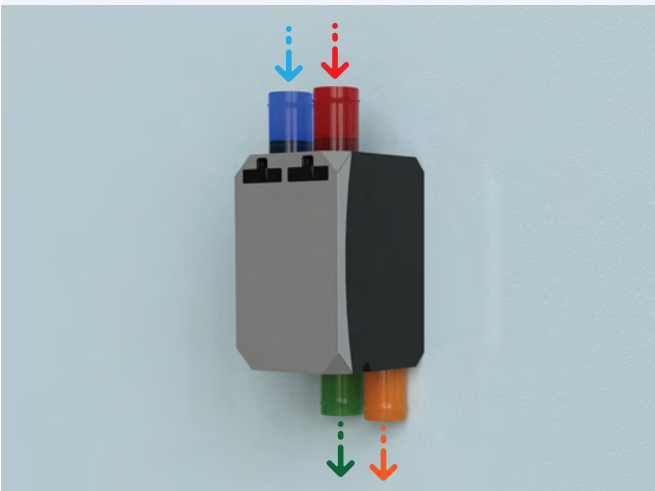

**Vertical Top In / Bottom Out Right**  
V-TIBO-R (factory set)

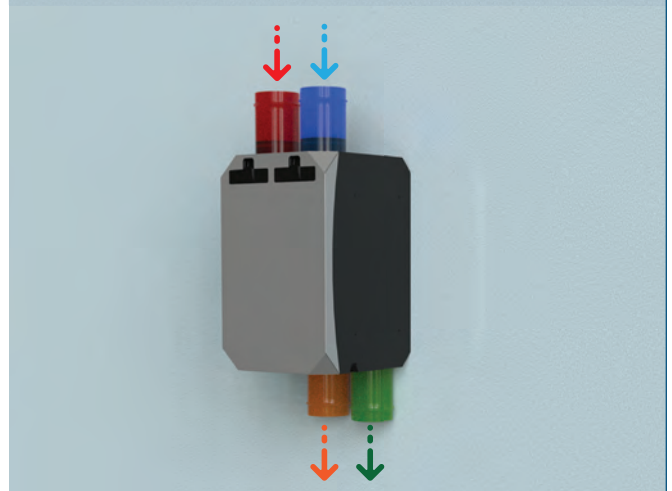

**Horizontal Left in / Right out Top**  
H-LIRO-T (factory set)

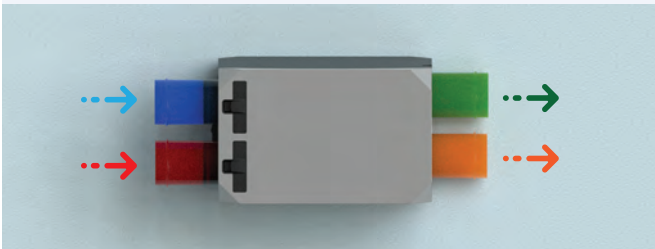

**Horizontal Right in / Left out Top**  
H-RILO-T

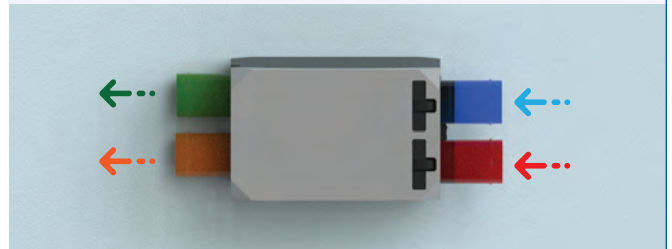

**Horizontal Left in / Right out Bottom**  
H-LIRO-B

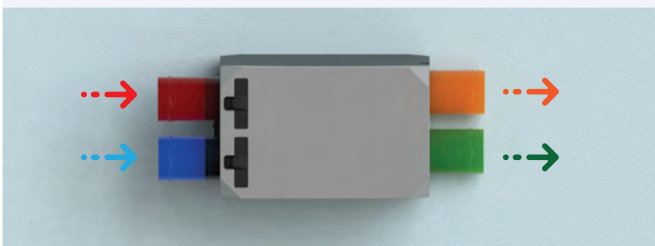

**Horizontal Right in / Left out Bottom**  
H-RILO-B (factory set)

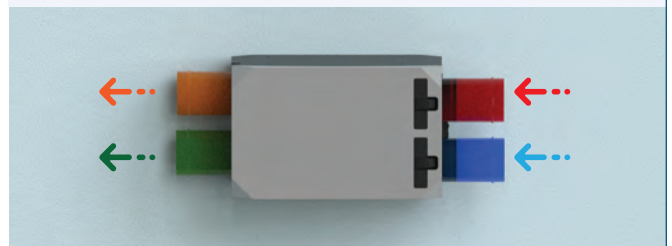

● Fresh air in    ● Extract air in    ● Exhaust air out    ● Supply air out

## Touch Screen Panel

The BSK NOTUS provides a comprehensive range of control options. All our units feature Wi-Fi connectivity, allowing users to take control of their units through their Android and iOS devices via our BSK Connect app. This user-friendly app offers convenient management of your BSK NOTUS unit.

There is an optional 4" touchscreen control interface where you can monitor and change various settings of your device. Additionally, a wireless touch panel which would eliminate the need for the extension cable is under development and will be available soon.

All of our units are equipped with the ModBus protocol, facilitating seamless integration with building automation systems. The unit can be set and used only with a ModBus connection, without the need for a display panel.



## BSK CloudControl

Additionally, for building managers or corporate housings, we offer a dedicated web tool "BSK CloudControl" that enables connection and monitoring of multiple devices. Through this interface, building managers can access individual device information, receive service notifications such as dirty filter alarms, and even set fan speed limits.





## Accessories

### Pre-heater



To prevent frost formation inside the device, in subzero outdoor conditions, it is recommended to install an electrical pre-heater. The electrical pre-heater can be seamlessly connected to the fresh air intake vent of your BSK NOTUS for effective cold weather operation.

### Water-heater



If your house is already heated by hot water, you can equip duct type water coils to the supply air vent to further heat the incoming air for a precise control of temperature. For buildings without the option for a water heater, we also offer electrical heaters.

### CO2 sensor module



You can add a CO2 sensor into your units Return Air side to monitor and control your CO2 levels in the house. When the CO2 levels rise above a user set limit, the device can enter boost mode to remove excess CO2 below the set limit. CO2 sensor is especially recommended for houses with fireplaces.

### F7 Filter

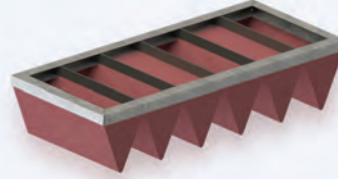



Standard G4 filters provide effective protection against dust and bigger particles. In cases where additional protection is required, especially for residents with allergies, we recommend opting for the F7 grade pollen filters. These filters offer enhanced filtration capabilities, specifically designed to capture smaller particles, ensuring a cleaner and healthier indoor environment.





BSK Ventilation Equipment INC.

 Mimar Sinan mah. Basra cad. No: 59 / A Sultanbeyli, İstanbul  
 +90 (216) 669 09 70  
 info@bskhvac.com

[www.bskhvac.com](http://www.bskhvac.com)